

LIST OF PARTS



MACHINE No. 246-1

** A TRADE MARK OF

THE SINGER MANUFACTURING COMPANY

INSTRUCTIONS FOR OILING

To ensure easy running and prevent unnecessary wear of the parts which are in movable contact, the machine requires oiling and when in continuous use, the oil gauge should be checked daily. The oil level should be maintained at the midpoint of the gauge.

To oil the machine, apply "TYPE A" OIL, sold only by Singer Sewing Machine Company, to the oil filler cup on top of the machine, as instructed in Form 20202.

INDEX

	Page
Accessories	15
Belt Guard (adjustable)	15
Fittings Complete 164493	14
Foot Lifter Parts	15
Machine Base	15
Machine No. 246-1	7
Numerical List of Parts	17
Thread Unwinder No. 151031 (Three Spools)	16
Thread Unwinder No. 151163 (Four Spools)	16

From the library of Diamond Needle Corp

INSTRUCTIONS FOR ORDERING

In ordering from this list, use **ONLY** the part NUMBER in the **FIRST** column.

The number stamped on a Sewing Machine Part is in every case the number of the single part only.

Every combination of parts sent out as such has its specific number, which, although not stamped on the parts, must be used when ordering the combination.

Each number always indicates the **SAME PART** in whatever list it appears, or for whatever machine.

The letters after some of the numbers indicate the style of finish only, as follows:

- A—Hardened, Polished, Nickel Plated and Buffed
- A.A—Buffed and Chromium Plated
- A.B—Hardened, Polished, Buffed and Chromium Plated
- A.C—Brown Baking Enamel Finish
- A.D—Gray Baking Enamel Finish
- A.E—Hardened, Bright Rumbled and Nickel Plated
- A.F—Hardened, Bright Rumbled, Nickel Plated, Bright Rumbled and Chromium Plated
- A.G—Alumilite, Plain
- A.H—Alumilite, Dyed
- A.J—Polished, Nickel Plated and Chromium Plated
- A.K—Hardened, Polished, Nickel Plated and Chromium Plated
- A.L—Heat Treated for Toughness
 - B—Polished, Nickel Plated and Buffed
 - C—Hardened Only
- A.R—Hardened and Merlized
 - D—Polished Only
 - E—Soft, Not Polished
 - F—Hardened and Polished
- F.J—Hardened, Polished and Nickel Plated
 - G—Bright Rumbled and Nickel Plated
- H—Blued
- J—Nickel Plated Only
- K—Hardened and Nickel Plated
- L—Brass Plated
- M—Oxidized
- N—Japanned, Dull
- P—Japanned, Bright
- P.P—Wrinkle Finish
- R—Merlized
- S—Cadmium Plated
- T—Copper Plated
 - T.A—Hardened, Polished, Copper and Nickel Plated and Buffed
 - T.B—Copper and Nickel Plated and Polished
 - T.J—Copper and Nickel Plated Only
 - T.K—Hardened, Copper and Nickel Plated
 - T.L—Copper and Brass Plated
 - T.M—Copper Plated and Oxidized

INSTRUCTIONS FOR ORDERING—Continued

- U—Zinc Plated
- V—Silver Plated
- W—Polished and Nickel Plated
- X—Black Oxide, for Iron and Steel
- X.C—Hardened and Black Oxide, for Iron or Steel
- Y—Black Nickel Plated Only
- Z—Chromium Plated
- Z.A—Hardened, Polished, Nickel Plated, Buffed and Chromium Plated
- Z.B—Polished, Nickel Plated, Buffed and Chromium Plated
- Z.C—Hardened and Chromium Plated
- Z.D—Polished and Chromium Plated
- Z.G—Bright Rumbled, Nickel Plated, Bright Rumbled and Chromium Plated
- Z.J—Nickel and Chromium Plated
- Z.T—Copper and Chromium Plated

These letters **MUST BE USED** when they appear in the list; and **AFTER** the number as in the list.

In this series:

1 to 1500, 50001 to 51500 and 140001 to 142000 are Screw Numbers

1501 to 1800 and 51501 to 51800 are Nut Numbers

1801 to 2000 and 51801 to 52000 are Roller Numbers

2001 to 50000 and 52001 to 140000 and 142001 to 190000 are Sewing Machine Parts, 190001 and upward are numbers of Electrical Parts.

The figures in the second column refer only to the plates, illustrating the parts, and are **NOT TO BE USED** in ordering.

Parts marked with an asterisk (*) are furnished only when repairs are made at factory.

SINGER Needles should be used
in SINGER Machines.
These Needles and their Containers
are marked with the
Company's Trade Mark "SIMANCO. **" 1

Needles in Containers marked
"FOR SINGER MACHINES"
are NOT **SINGER** made needles. 2

LIST OF PARTS COMPLETE
FOR

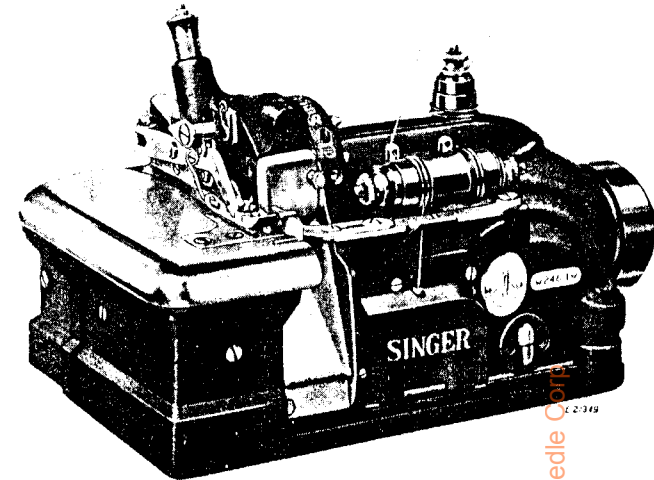

MACHINE No. 246-1

SINGER Needles should be used
in SINGER Machines.
These Needles and their Containers
are marked with the
Company's Trade Mark "SIMANCO.***" 1

Needles in Containers marked
"FOR SINGER MACHINES"
are NOT **SINGER** made needles. 2

No.	Plate	Name
164001	24767	Chip Guard.....
1209J	24767	Chip Guard Screw (lower).....
140509J	24767	Chip Guard Screw (upper).....
164107	24767	Cloth Plate.....
164002	24767	Cloth Plate Extension.....
914J	24767	Cloth Plate Extension Screw (2).....
1700J	24767	Cloth Plate Extension Screw Nut.....
164205	24767	Cloth Plate Lock Spring.....
1700J	24767	Cloth Plate Lock Spring Nut.....
1250AL	24767	Cloth Plate Lock Spring Screw Stud.....
164104	24767	Cloth Plate Plunger.....
164105	24767	Cloth Plate Plunger Spring.....
624AL	24767	Cloth Plate Plunger Set Screw.....
164106	24767	Cloth Plate Position Collar with two 624AL.....
624AL	24767	Cloth Plate Position Collar Set Screw (2).....
164108	24767	Cloth Plate with Extension complete, Nos. 164002, 164107, 164205 and two each 914J and 1700J.....
164294	24807	Cover, for covering Knife (movable) Mechanism Opening.....
164006	24797	Feed Bar with 164010.....
164017	24797	Feed Bar Connection.....
164008	24797	Feed Bar Connection Bearing.....
164009	24797	Feed Bar Connection Hinge Screw Stud.....
1671C	24797	Feed Bar Connection Hinge Screw Stud Nut.....
164010	24797	Feed Bar Connection Hinge Screw Stud Nut Position Pin.....
164277	24797	Feed Bar Guide Roller.....
164003	24797	Feed Bar Hinge Pin (eccentric).....
1389C	24797	Feed Bar Hinge Pin Set Screw.....
164004	24797	Feed Bar Slide Block (back).....
1628C	24797	Feed Bar Slide Block (back) Nut.....

From the library of: Diamond Needle Corp.

No.	Plate	Name
17022	24797	Feed Bar Slide Block (back) Nut Washer
164005	24797	Feed Bar Slide Block (front)
164278	24797	Feed Bar Spacing Collar
164276		Feed Bar complete, Nos. 1671C, 164004, 164005, 164006, 164008, 164009 and 164017
164469	24808	Feed Dog
1454F	24808	Feed Dog Screw
164020	24797	Feed Eccentric
	NOTE:	Feed Eccentric No. 164020 is furnished in 4 to 16 and 18 stitches to the inch, unless otherwise stated No. 164020 (5 stitches to the inch) is supplied regularly.
164398	24797	Feed Eccentric Cover
164400	24797	Feed Eccentric Cover Bracket with 164345
157C	24797	Feed Eccentric Cover Bracket Screw
629K	24797	Feed Eccentric Cover Hinge Screw
164401	24797	Feed Eccentric Cover Latch Spring
227J	24797	Feed Eccentric Cover Latch Spring Screw (2)
164403	24797	Feed Eccentric Cover complete, Nos. 629K, 164398, 164400, 164401 and two 227J
164345	24797	Feed Eccentric Cover Oil Wick
164025	24755	Feed Lifting Eccentric
164530	24808	Guide (swing-out)
164297	24808	Guide (swing-out) Arm
164298	24808	Guide (swing-out) Arm Holder
50267R	24808	Guide (swing-out) Arm Holder Screw (2)
164541	24808	Guide (swing-out) Arm Lock Spring
1423J	24808	Guide (swing-out) Arm Lock Spring Screw
1550J	24808	Guide (swing-out) Arm Lock Spring Screw Nut
164502	24808	Guide (swing-out) Extension (lower)
164299	24808	Guide (swing-out) Extension (upper)
197J	24808	Guide (swing-out) Extension Screw
164503		Guide (swing-out) with Extensions complete, Nos. 197J, 164299, 164502 and 164530
1425J	24808	Guide (swing-out) Hinge Screw
42436	24808	Guide (swing-out) Hinge Screw Friction Washer
164311	24808	Guide (swing-out) with Arm and Holder complete, Nos. 1423J, 1425J, 1550J, 42436, 164297, 164298, 164503, 164541 and two 1443J
1443J	24808	Guide (swing-out) Screw (2)
164462	24807	Lint Stripper with 735AL
735AL	24807	Lint Stripper Set Screw
164045	24809	Looper
164046	24809	Looper Carrier with 460AL, 50379F and 164202
164047	24809	Looper Carrier Holder with 140393AL and 140596AL
164212		Looper Carrier Holder 164047 with 1324C, 59456 and 164046
140596AL		Looper Carrier Holder Set Screw (left)
140393AL	24809	Looper Carrier Holder Set Screw (right)
1324C	24809	Looper Carrier Screw
460AL	24809	Looper Carrier Screw Set Screw
59456	24809	Looper Carrier Screw Washer
164048	24809	Looper Driving Shaft
164049	24809	Looper Driving Shaft Bushing (back)
140394E	24809	Looper Driving Shaft Bushing (back) Cap Screw
164293	24809	Looper Driving Shaft Bushing (back) Cap Screw Washer
164050	24809	Looper Driving Shaft Bushing (front)
164051	24809	Looper Driving Shaft Crank with 1083C
164215		Looper Driving Shaft Crank 164051 with 164052
1083C	24809	Looper Driving Shaft Crank Clamping Screw
164052	24755	Looper Driving Shaft Crank Connection with two each 171AL and 140159AL
171AL	24755	Looper Driving Shaft Crank Connection Cap (lower) Screw (2)

No.	Plate	Name
140159AL	24755	Looper Driving Shaft Crank Connection Cap (upper) Screw (2)
164067	24809	Looper Driving Shaft Crank Key
1324C	24809	Looper Driving Shaft Crank Key Screw
45057	24809	Looper Driving Shaft Crank Key Screw Washer
164053	24809	Looper Driving Shaft Crank Thrust Bearing
50379F	24809	Looper Set Screw
164202	24809	Looper Stop Pin
164054	24808	Looper Thread Tube
853AL	24808	Looper Thread Tube Set Screw
*164072		Machine Frame
*164526		Machine Frame complete, Nos. 140396E, 164072, 164077, 164528 and three 140395C
164074	24756	Machine Frame Bottom Cover
164075	24756	Machine Frame Bottom Cover Gasket
914C	24756	Machine Frame Bottom Cover Screw (13)
*164527		Machine Frame Bracket
*164528		Machine Frame Bracket 164527 with 164207 and two 187E
164207	24759	Machine Frame Bracket Key
187E	24759	Machine Frame Bracket Key Screw (2)
140396E	24759	Machine Frame Bracket Screw (large)
164077	24759	Machine Frame Bracket Screw (large) Washer (fiber)
164229	24759	Machine Frame Bracket Screw (large) Washer (felt)
140395C	24759	Machine Frame Bracket Screw (small) (3)
164078	24756	Machine Frame Cover (back)
50571J	24756	Machine Frame Cover (back) Screw (long) (2)
914J	24756	Machine Frame Cover (back) Screw (short)
164079	24756	Machine Frame Cover (back) Slide
140200J	24756	Machine Frame Cover (back) Slide Position Screw
238J	24756	Machine Frame Cover (back) Slide Stop Screw
164080	24756	Machine Frame Cover (back) complete, Nos. 238J, 1637K, 140200J, 140228C, 164078 and 164079
164081	24759	Machine Frame Oil Lead
140088R	24759	Machine Frame Oil Lead Screw
1698J	24759	Machine Frame Oil Lead Screw Nut
164082	24759	Machine Frame Oil Plug Bracket
1036AL	24759	Machine Frame Oil Plug Bracket Set Screw
164083	24759	Machine Frame Oil Screen
206J	24759	Machine Frame Oil Screen Screw (3)
164084	24759	Machine Frame Oil Splash Guard (internal)
164492	24810	Machine Frame Oil Splash Guard (top)
51023W	24810	Machine Frame Oil Splash Guard (top) Screw (2)
164086	24759	Machine Frame Oil Tube with 164087
50421AL	24759	Machine Frame Oil Tube Set Screw
164087	24759	Machine Frame Oil Tube Wick
164461		Machine Frame Oil Tube Wick Retainer
164088	24755	Machine Frame Plug
164089	24755	Machine Frame Rotary Shaft
164090		Machine Frame Rotary Shaft 164089 with 164097, 164215, 164216, 164217 and two each 164093 and 164232
139026	24755	Machine Frame Rotary Shaft Ball Bearing
164092	24755	Machine Frame Rotary Shaft Ball Bearing Housing
51369C	24755	Machine Frame Rotary Shaft Ball Bearing Housing Screw (3)
164093	24755	Machine Frame Rotary Shaft Ball Sleeve (two pieces) (2)
164232	24755	Machine Frame Rotary Shaft Ball Sleeve Guide (2)
164094	24755	Machine Frame Rotary Shaft Bushing (front)
1036AL	24755	Machine Frame Rotary Shaft Bushing (front) Set Screw
164095	24755	Machine Frame Rotary Shaft Bushing (intermediate)
51332C	24755	Machine Frame Rotary Shaft Bushing (intermediate) Set Screw
164096	24755	Machine Frame Rotary Shaft Counterbalance with 1036AL
1036AL	24755	Machine Frame Rotary Shaft Counterbalance Set Screw

From the library of: Dick Nelson

No.	Plate	Name
164097	24755	Machine Frame Rotary Shaft Key
51649C	24755	Machine Frame Rotary Shaft Nut
131056	24755	Machine Frame Rotary Shaft Nut Washer
164098	24755	Machine Frame Rotary Shaft Oil Sling and Ball Bearing Grease Retainer
164099	24755	Machine Frame Rotary Shaft Screw Stud
164100	24755	Machine Frame Rotary Shaft Thrust Bearing
164101	24772	Machine Frame Top Cover
164214		Machine Frame Top Cover 164101 with 330J, 164103 and two 164418
164102	24772	Machine Frame Top Cover Gasket
164103	24772	Machine Frame Top Cover Oil Lead
330J	24772	Machine Frame Top Cover Oil Lead Screw
51369J	24772	Machine Frame Top Cover Screw (3)
164231	24755	Machine Pulley (round belt and "V" belt) with two 448AL
164071	24755	Machine Pulley Cap
140416X	24755	Machine Pulley Cap Screw
448AL	24755	Machine Pulley Set Screw (2)
164109	24810	Needle Clamp
51720C	24810	Needle Clamping Nut
164110	24810	Needle Driving Shaft with 164118
164275		Needle Driving Shaft 164110 with 51720C, 164109 and 164117
164111	24810	Needle Driving Shaft Bushing
164112	24810	Needle Driving Shaft Bushing Cap
164113	24810	Needle Driving Shaft Bushing Oil Lead
452C	24810	Needle Driving Shaft Bushing Oil Lead Hole Plug Screw
164114	24810	Needle Driving Shaft Crank with 1083C and two 140596AL
164115	24810	Needle Driving Shaft Crank Ball
1083C	24810	Needle Driving Shaft Crank Clamping Screw
164116	24755	Needle Driving Shaft Crank Connection with two each 171AL and 896AL
164217		Needle Driving Shaft Crank Connection 164116 with 164115
896AL	24755	Needle Driving Shaft Crank Connection Cap (lower) Screw (2)
171AL	24755	Needle Driving Shaft Crank Connection Cap (upper) Screw (2)
140596AL	24810	Needle Driving Shaft Crank Set Screw (2)
164117	24810	Needle Holder
164118	24810	Needle Stop Pin
164119	24755	Oil Agitator
164120	24759	Oil Cooler with two 164125
164121	24759	Oil Cooler Cover
164123	24759	Oil Cooler Cover 164121 with 164135
164122	24759	Oil Cooler Cover Gasket
145J	24759	Oil Cooler Cover Screw
164124	24759	Oil Cooler Gasket
164125	24759	Oil Cooler Oil Pipe (outlet) (2)
164126	24759	Oil Cooler Oil Tube with 138269 and 164128
164127	24759	Oil Cooler Oil Tube Coupling
51630	24759	Oil Cooler Oil Tube Lock Nut
138269	24759	Oil Cooler Oil Tube Sleeve
164128	24759	Oil Cooler Oil Tube Wick
51139J	24759	Oil Cooler Screw (long) (2)
1324J	24759	Oil Cooler Screw (short)
164131	24759	Oil Sight Gauge Background Disc
164132	24759	Oil Sight Gauge Background Disc Gasket
164133	24759	Oil Sight Gauge Window
164132	24759	Oil Sight Gauge Window Gasket
164134	24759	Oil Sight Gauge Window Retainer
164132	24759	Oil Sight Gauge Window Retainer Gasket
1485J	24759	Oil Sight Gauge Window Retainer Screw (2)
164135	24759	Oil Cup for filling Machine

No.	Plate	Name
164136	24807	Presser Bar Bracket
164034	24807	Presser Bar Bracket Stud
164035		Presser Bar Bracket Stud 164034 with 164036 and 164269
164036	24807	Presser Bar Bracket Stud Oil Wick (long)
164269		Presser Bar Bracket Stud Oil Wick (short)
50421AL	24807	Presser Bar Bracket Stud Set Screw (back)
1143AL	24807	Presser Bar Bracket Stud Set Screw (top)
164137	24810	Presser Bar Lifting Bracket with 462AL, 624AL and 51846
51846	24810	Presser Bar Lifting Bracket Roller and Stud
624AL	24810	Presser Bar Lifting Bracket Set Screw (long)
462AL	24810	Presser Bar Lifting Bracket Set Screw (short)
164138	24810	Presser Bar Lifting Lever
164139	24810	Presser Bar Lifting Lever Spring
140228C	24756	Presser Bar Lifting Lever Stop Screw
1637K	24756	Presser Bar Lifting Lever Stop Screw Nut
164350	24807	Presser Bar (swing-out)
164141	24807	Presser Bar (swing-out) Lifting Screw Stud
1700J	24807	Presser Bar (swing-out) Lifting Screw Stud Nut
164142	24810	Presser Bar (swing-out) Opening Lever
50060K	24810	Presser Bar (swing-out) Opening Lever Hinge Screw
140510C	24807	Presser Bar (swing-out) Pivot Screw
164351	24807	Presser Bar (swing-out) Pivot Screw Lock Washer
51362AL	24807	Presser Bar (swing-out) Pivot Screw Lock Washer Screw
164143	24810	Presser Bar (upright)
164246	24810	Presser Bar (upright) Housing
50073J	24810	Presser Bar (upright) Housing Screw (2)
164247		Presser Bar (upright) Housing complete, Nos. 50060K, 164137, 164138, 164139, 164142, 164143, 164144, 164194 and 164246
164144	24810	Presser Bar (upright) Spring
164416		Presser Bar (upright) Spring (heavy)
164471	24808	Presser Foot Body
164438	24808	Presser Foot Chaining-off Finger for 164474
164146	24808	Presser Foot Chaining-off Finger for 164475
164147	24808	Presser Foot Clamping Plate
50225J	24808	Presser Foot Clamping Plate Screw
164303	24808	Presser Foot Guide
51229J	24808	Presser Foot Guide Screw
164474	24808	Presser Foot complete, for light and medium fabrics, Nos. 50225J, 51229J, 164147, 164303, 164438 and 164471
164475	24808	Presser Foot complete, for heavy-weight fabrics, Nos. 50225J, 51229J, 164146, 164147, 164303 and 164471
164476	24808	Presser Foot Thread Chain Guard
140180J	24808	Presser Foot Thread Chain Guard Screw
164194	24810	Pressure Regulating Thumb Screw
164252	24809	Spreader
164056	24809	Spreader Carrier with 50370E
164057	24809	Spreader Carrier Connection
164058	24809	Spreader Carrier Connection Guide Bar with 624AL and 168215
168215		Spreader Carrier Connection Guide Bar Oil Wick
624AL	24809	Spreader Carrier Connection Guide Bar Plug Screw
164463	24809	Spreader Carrier Connection Guide Bar Bracket with 164060 and two 462AL
164060	24809	Spreader Carrier Connection Guide Bar Bracket Oil Pad
914C	24809	Spreader Carrier Connection Guide Bar Bracket Screw (left)
1057AL	24809	Spreader Carrier Connection Guide Bar Bracket Screw (right)
462AL	24809	Spreader Carrier Connection Guide Bar Set Screw (2)
164061	24809	Spreader Carrier Connection Hinge Stud with 1019AL
1443J	24809	Spreader Carrier Connection Hinge Stud Cap Screw
164397	24809	Spreader Carrier Connection Hinge Stud Adjusting Pin
1019AL	24809	Spreader Carrier Connection Hinge Stud Adjusting Pin Set Screw

No.	Plate	Name
132565	24809	Spreader Carrier Hinge Pin
50370E	24809	Spreader Carrier Hinge Pin Set Screw
164062	24809	Spreader Driving Lever with 1083C and two 140596AL
164464		Spreader Driving Lever 164062 with 1443J, 1700J, 132565, 164056, 164057, 164058, 164061, 164068, 164397 and 164463
1083C	24809	Spreader Driving Lever Clamping Screw
140596AL	24809	Spreader Driving Lever Set Screw (2)
164063	24809	Spreader Driving Shaft
164049	24809	Spreader Driving Shaft Bushing (back)
140394E	24809	Spreader Driving Shaft Bushing (back) Cap Screw
164293	24809	Spreader Driving Shaft Bushing (back) Cap Screw Washer (fiber)
164066	24809	Spreader Driving Shaft Bushing (front)
164066	24809	Spreader Driving Shaft Crank with 1083C
164216		Spreader Driving Shaft Crank 164066 with 164052
1083C	24809	Spreader Driving Shaft Crank Clamping Screw
164052	24755	Spreader Driving Shaft Crank Connection with two each 171AL and 140159AL
171AL	24755	Spreader Driving Shaft Crank Connection Cap (lower) Screw (2)
140159AL	24755	Spreader Driving Shaft Crank Connection Cap (upper) Screw (2)
164067	24809	Spreader Driving Shaft Crank Key
1324C	24809	Spreader Driving Shaft Crank Key Screw
45057	24809	Spreader Driving Shaft Crank Key Screw Washer
164053	24809	Spreader Driving Shaft Crank Thrust Bearing
164068	24809	Spreader Locking Screw Stud
1700J	24809	Spreader Locking Screw Stud Nut
164219	24809	Spreader Position Collar with 904E
904E	24809	Spreader Position Collar Set Screw
2102	24772	Tension (heavy) Disc (4)
164155	24772	Tension (heavy) Regulating Thumb Nut (2)
50133C	24772	Tension (heavy) Screw Stud (2)
164156		Tension (heavy) Screw Stud 50133C with 164155 (2)
164161	24772	Tension (heavy) Spring (2)
59537	24772	Tension (heavy) Spring Bushing (2)
164158	24772	Tension (heavy) Spring Cover (2)
164162	24772	Tension (heavy) complete, Nos. 59537, 164156, 164158, 164161 and two 2102 (2)
2102	24772	Tension (light) Disc (2)
164155	24772	Tension (light) Regulating Thumb Nut
50133C	24772	Tension (light) Screw Stud
164156		Tension (light) Screw Stud 50133C with 164155
164157	24772	Tension (light) Spring
59537	24772	Tension (light) Spring Bushing
164158	24772	Tension (light) Spring Cover
164160	24772	Tension (light) complete, Nos. 59537, 164156, 164157, 164158 and two 2102
164285	24772	Tension (looper thread) Thread Guide (left)
164286	24772	Tension (looper thread) Thread Guide (right)
164159	24772	Tension (needle thread) Thread Guide
164418	24772	Tension Thread Eyelet (2)
164167	24761	Thread (looper) Plate with 624AL
164168	24761	Thread (looper) Plate Cover
164206		Thread (looper) Plate Cover 164168 with 164169 and 164170
164169	24761	Thread (looper) Plate Cover Hinge
164170	24761	Thread (looper) Plate Cover Hinge Pin
164171	24761	Thread (looper) Plate Cover Spring (2)
332J	24761	Thread (looper) Plate Cover Spring Screw (2)
896AL	24761	Thread (looper) Plate Screw (2)
164173	24761	Thread (looper) Plate Thread Bushing
50318W	24761	Thread (looper) Plate Thread Bushing Screw
164174		Thread (looper) Plate complete, Nos. 1423J, 1443J, 1607J, 50318W, 164163, 164164, 164165, 164166, 164167, 164173, 164206 and two each 332J and 164171

No.	Plate	Name
164091	24809	Thread (looper) Stripper and Take-up
164163	24761	Thread (looper) Stripper and Take-up Eyelet (adjustable)
1443J	24761	Thread (looper) Stripper and Take-up Eyelet (adjustable) Screw
187E	24809	Thread (looper) Stripper and Take-up Screw
17022	24809	Thread (looper) Stripper and Take-up Screw Washer
164175	24809	Thread (looper) Take-up
164176	24809	Thread (looper) Take-up Plate
176E	24809	Thread (looper) Take-up Screw (lower)
1443J	24809	Thread (looper) Take-up Screw (upper)
164164	24761	Thread (looper) Thread Eyelet (movable)
1423J	24761	Thread (looper) Thread Eyelet Screw
164165	24761	Thread (looper) Thread Eyelet (stationary)
1607J	24761	Thread (looper) Thread Eyelet (stationary) Nut
164166	24761	Thread (looper) Tube
624AL	24761	Thread (looper) Tube Set Screw
164381	24811	Thread (needle) Controller
164153	24807	Thread (needle) Controller Lever
164031	24807	Thread (needle) Controller Lever Driving Lever with 620AL
164211		Thread (needle) Controller Lever Driving Lever 164031 with 132583, 164035, 164136 and 164153
164032	24807	Thread (needle) Controller Lever Driving Lever Bearing
50421AL	24807	Thread (needle) Controller Lever Driving Lever Bearing Set Screw (long)
624AL	24807	Thread (needle) Controller Lever Driving Lever Bearing Set Screw (short)
164180	24807	Thread (needle) Controller Lever Driving Lever Guide
164181	24807	Thread (needle) Controller Lever Driving Lever Guide Holder with two 140239AL
140239AL	24807	Thread (needle) Controller Lever Driving Lever Guide Holder Set Screw (2)
164210	24807	Thread (needle) Controller Lever Driving Lever Guide Holder 164181 with 197J, 164177, 164180 and 164182
140239AL	24807	Thread (needle) Controller Lever Driving Lever Guide Holder Set Screw
164182	24807	Thread (needle) Controller Lever Driving Lever Guide Holder Thread Tube
50421AL	24807	Thread (needle) Controller Lever Driving Lever Guide Holder Thread Tube Set Screw
197J	24807	Thread (needle) Controller Lever Driving Lever Guide Screw
132583	24807	Thread (needle) Controller Lever Driving Lever Hinge Pin with 132584
132584	24807	Thread (needle) Controller Lever Driving Lever Hinge Pin Oil Wick
620AL	24807	Thread (needle) Controller Lever Driving Lever Hinge Pin Set Screw
1443B	24807	Thread (needle) Controller Screw
164177	24807	Thread Eyelet (needle thread)
164440	24808	Throat Plate
164179	24808	Throat Plate Guide with 853AL
1454E	24808	Throat Plate Guide Screw
1094F	24808	Throat Plate Screw (2)

SET OF FITTINGS COMPLETE

No. 164493

FOR

PANTS SERGING FOR LIGHT

AND MEDIUM OR HEAVY-WEIGHT FABRICS,

FOR TWO-THREAD STITCH, 1/4 INCH BIGHT

NOTE: This Machine is regularly fitted with Set No. 164493.

No.	Plate	Name
164469	24811	Feed Dog
164530	24811	Guide (swing-out)
164297	24811	Guide (swing-out) Arm
164298	24811	Guide (swing-out) Arm Holder
50267R	24811	Guide (swing-out) Arm Holder Screw (2)
164541	24811	Guide (swing-out) Arm Lock Spring
1423J	24811	Guide (swing-out) Arm Lock Spring Screw
1550J	24811	Guide (swing-out) Arm Lock Spring Screw Nut
164502	24811	Guide (swing-out) Extension (lower)
164299	24811	Guide (swing-out) Extension (upper)
197J	24811	Guide (swing-out) Extension Screw
164503		Guide (swing-out) with Extensions complete, Nos. 197J, 164299, 164502 and 164530
1425J	24811	Guide (swing-out) Hinge Screw
42436	24811	Guide (swing-out) Hinge Screw Washer
1443J	24811	Guide (swing-out) Screw (2)
164311	24811	Guide (swing-out) with Arm and Holder complete, Nos. 1423J, 1425J, 1550J, 42436, 164297, 164298, 164503, 164541 and two 1443J
164492	24811	Machine Frame Oil Splash Guard (top)
164350	24811	Presser Bar (swing-out)
164471	24811	Presser Foot Body
164438	24811	Presser Foot Chaining-off Finger for 164474
164146	24811	Presser Foot Chaining-off Finger for 164475
164147	24811	Presser Foot Clamping Plate
50225J	24811	Presser Foot Clamping Plate Screw
164303	24811	Presser Foot Guide
51229J	24811	Presser Foot Guide Screw
164474	24811	Presser Foot complete, for light and medium fabrics, Nos. 50225J, 51229J, 164147, 164303, 164438 and 164471
164475	24811	Presser Foot complete, for heavy-weight fabrics, Nos. 50225J, 51229J, 164146, 164147, 164303 and 164471
164476	24811	Presser Foot Thread Chain Guard
140180J	24811	Presser Foot Thread Chain Guard Screw
164252	24811	Spreader
164091	24811	Thread (looper) Stripper and Take-up
164175	24811	Thread (looper) Take-up
164381	24811	Thread (needle) Controller
164440	24811	Throat Plate
164179	24811	Throat Plate Guide with 853AL
164493	24811	Set of Fittings complete, Nos. 140180J, 164091, 164175, 164179, 164252, 164311, 164350, 164381, 164440, 164469, 164474 or 164475, 164476, 164492 and two 50267R

ACCESSORIES

No.	Plate	Name
164203	24801	Feed Eccentric Extractor (not regularly furnished with machine)
164459	24801	Gauge (not regularly furnished with machine)
160725	24801	Oil Container
160727	24801	Oil Container (filled, 5 oz. mfg. oil, light grade, not stainless) Nos. 160725 and 160726
160726	24801	Oil Container Cap
160728	24801	Oil Container Spout, for use when filling Oil Reservoir
164198	24801	Presser Bar Lifting Chain Spring (under table)
26026	24801	Screw Driver
164196	24801	Threader (6)
164204	24801	Tweezers
164197	24801	Wrench (socket)
10875		Wrench (flat) for 1701 and 51649

BELT GUARD (ADJUSTABLE)

164183	24763	Belt Guard
164199	24763	Belt Guard Bracket (back)
164200	24763	Belt Guard Bracket (front)
51326J	24763	Belt Guard Screw (2)
164201	24763	Belt Guard (adjustable) complete, Nos. 164183, 164199, 164200 and two each 51326J and wood screws 3/4 in. No. 7 F.H.

FOOT LIFTER PARTS

6439	24763	Chain, 36 in. to 45 in. with 56864 and 56865
		NOTE: When ordering No. 6439, give length required.
4879	24763	Chain Connecting Link
56864	24763	Chain Hook (large)
56865	24763	Chain Hook (small)
4881	24763	Treadle
4882	24763	Treadle Shaft
4883		Treadle Spring
4884	24763	Treadle Stand
4885	24763	Treadle complete, Nos. 4879, 4881, 4882, 4883, 4884 and two wood screws 1 in. No. 16 F.H.

MACHINE BASE

164184	24763	Machine Base with 50608R, 139017 and two each wood screws 3/4 in. No. 8 R.H. and 1 1/4 in. No. 6 F.H.
50608R	24763	Machine Base Plug Screw
139017	24763	Machine Base Plug Screw Washer
164188	24763	Machine Cushion (large) (2)
164189	24763	Machine Cushion (small) (2)
164190	24763	Machine Pad (felt)
140418E	24755	Machine Screw Stud (back)
657E	24755	Machine Screw Stud (front)

From the library of: Diamond Needle Corp

THREAD UNWINDER No. 151031

FOR THREE SPOOLS

No.	Plate	Name
228692		Spool Pin (3)
201528X		Spool Pin Nut (3)
395243		Spool Pin Washer (3)
151023	24764	Spool Rest with 858AL and three each 201528X, 228692 and 395243
150203	24764	Spool Rest Cushion (felt) (3)
858AL	24764	Spool Rest Hub Set Screw
151024	24764	Spool Rest Rod
1122C	24764	Spool Rest Rod Set Screw (2)
151025	24764	Spool Rest Stand with two 1122C and three wood screws 1 in. No. 12 F.H.
151026	24764	Thread Guide (lower)
50311C	24764	Thread Guide (lower) Holder Set Screw
151027	24764	Thread Guide (lower) Support with 50311C
151028	24764	Thread Guide (upper, hollow) (2)
151029	24764	Thread Guide (upper) Holder with four 453AL
453AL	24764	Thread Guide Set Screw (3)
151030	24764	Thread Guide Rod
453AL	24764	Thread Guide Rod Set Screw
151031	24764	Thread Unwinder complete, Nos. 151023, 151024, 151025, 151026, 151027, 151029, 151030, two 151028 and three 150203

THREAD UNWINDER No. 151163

FOR FOUR SPOOLS

228692	24806	Spool Pin (4)
201528X		Spool Pin Nut (4)
228693		Spool Pin Washer for 225259
395243		Spool Pin Washer for 151023 (3)
151023	24806	Spool Rest with 858AL and three each 201528X, 228692 and 395243 (three spools)
225259	24806	Spool Rest with 201018C, 201528X, 228692 and 228693 (one spool)
150203	24806	Spool Rest Cushion (felt) (4)
858AL	24806	Spool Rest Hub Set Screw for 151023
151024	24806	Spool Rest Rod
1122C	24806	Spool Rest Rod Set Screw (2)
201018C	24806	Spool Rest Set Screw for 225259
151025	24806	Spool Rest Stand with two 1122C and three wood screws 1 in. No. 12 F.H.
151026	24806	Thread Guide (lower)
50311C	24806	Thread Guide (lower) Holder Set Screw
151027	24806	Thread Guide (lower) Support with 50311C
151028	24806	Thread Guide (upper, hollow) (2)
151162	24806	Thread Guide (upper, solid)
151029	24806	Thread Guide (upper) Holder with four 453AL
453AL	24806	Thread Guide Set Screw (3)
151030	24806	Thread Guide Rod
453AL	24806	Thread Guide Rod Set Screw
151163	24806	Thread Unwinder complete, Nos. 151023, 151024, 151025, 151026, 151027, 151029, 151030, 151162, 225259, two 151028 and four 150203

NUMERICAL LIST OF PARTS

No.	Plate	Name
145J	24759	Oil Cooler Cover Screw
157C	24797	Feed Eccentric Cover Bracket Screw
171AL	24755	Looper Driving Shaft Crank Connection Cap (lower) Screw for 164052 (2)
171AL	24755	Needle Driving Shaft Crank Connection Cap (upper) Screw for 164116 (2)
171AL	24755	Spreader Driving Shaft Crank Connection Cap (lower) Screw for 164052 (2)
176E	24809	Thread (looper) Take-up Screw (lower)
187E	24759	Machine Frame Bracket Key Screw for 164528 (2)
187E	24809	Thread (looper) Stripper and Take-up Screw
197J	24808	Guide (swing-out) Extension Screw for 164503
197J	24807	Thread (needle) Controller Lever Driving Lever Guide Screw for 164210
206J	24759	Machine Frame Oil Screen Screw (3)
227J	24797	Feed Eccentric Cover Latch Spring Screw for 164403 (2)
238J	24756	Machine Frame Cover (back) Slide Stop Screw for 164080
330J	24772	Machine Frame Top Cover Oil Lead Screw for 164214
332J	24761	Thread (looper) Plate Cover Spring Screw for 164174 (2)
448AL	24755	Machine Pulley Set Screw for 164231 (2)
452C	24810	Needle Driving Shaft Bushing Oil Lead Hole Plug Screw
453AL	24764	Thread Unwinder Thread Guide Set Screw for 151029 (3)
453AL	24764	Thread Unwinder Thread Guide Rod Set Screw for 151029 and 151163
460AL	24809	Looper Carrier Screw Set Screw for 164046
462AL	24810	Presser Bar Lifting Bracket Set Screw (short) for 164137
462AL	24809	Spreader Carrier Connection Guide Bar Set Screw for 164463 (2)
620AL	24807	Thread (needle) Controller Lever Driving Lever Hinge Pin Set Screw for 164031
624AL	24767	Cloth Plate Plunger Set Screw
624AL	24767	Cloth Plate Position Collar Set Screw for 164106 (2)
624AL	24810	Presser Bar Lifting Bracket Set Screw (long) for 164137
624AL	24809	Spreader Carrier Connection Guide Bar Plug Screw for 164058
624AL	24761	Thread (looper) Tube Set Screw for 164167
624AL	24807	Thread (needle) Controller Lever Driving Lever Bearing Set Screw (short)
629K	24797	Feed Eccentric Cover Hinge Screw for 164403
657E	24755	Machine Screw Stud (front)
735AL	24807	Lint Stripper Set Screw for 164462
853AL	24808	Looper Thread Tube Set Screw for 164179
858AL	24764	Thread Unwinder Spool Rest Hub Set Screw for 151023
896AL	24755	Needle Driving Shaft Crank Connection Cap (lower) Screw for 164116 (2)
896AL	24761	Thread (looper) Plate Screw (2)
904E	24809	Spreader Position Collar Set Screw for 164219
914J	24767	Cloth Plate Extension Screw for 164108 (2)
914C	24756	Machine Frame Bottom Cover Screw (13)
914J	24756	Machine Frame Cover (back) Screw (short)
914C	24809	Spreader Carrier Connection Guide Bar Bracket Screw (left)
1019AL	24809	Spreader Carrier Connection Hinge Stud Adjusting Pin Set Screw for 164061
1036AL	24759	Machine Frame Oil Plug Bracket Set Screw
1036AL	24755	Machine Frame Rotary Shaft Bushing (front) Set Screw
1036AL	24755	Machine Frame Rotary Shaft Counterbalance Set Screw for 164096
1057AL	24809	Spreader Carrier Connection Guide Bar Bracket Screw (right)
1083C	24809	Looper Driving Shaft Crank Clamping Screw for 164051

No.	Plate	Name
1083C	24810	Needle Driving Shaft Crank Clamping Screw for 164114
1083C	24809	Spreader Driving Lever Clamping Screw for 164062
1083C	24809	Spreader Driving Shaft Crank Clamping Screw for 164066
1094F	24808	Throat Plate Screw (2)
1122C	24764	Thread Unwinder Spool Rest Rod Set Screw for 151025 (2)
1143AL	24807	Presser Bar Bracket Stud Set Screw (top)
1209J	24767	Chip Guard Screw (lower)
1250AL	24767	Cloth Plate Lock Spring Screw Stud
1324C	24809	Looper Carrier Screw for 164212
1324C	24809	Looper Driving Shaft Crank Key Screw
1324C	24759	Oil Cooler Screw (short)
1324C	24809	Spreader Driving Shaft Crank Key Screw
1389C	24797	Feed Bar Hinge Pin Set Screw
1423J	24808	Guide (swing-out) Arm Lock Spring Screw for 164311
1423J	24761	Thread (looper) Thread Eyelet Screw for 164174
1425J	24808	Guide (swing-out) Hinge Screw for 164311
1443J	24808	Guide (swing-out) Screw for 164311 (2)
1443J	24809	Spreader Carrier Connection Hinge Stud Cap Screw for 164464
1443J	24761	Thread (looper) Stripper and Take-up Eyelet (adjustable) Screw for 164174
1443J	24809	Thread (looper) Take-up Screw (upper)
1443B	24807	Thread (needle) Controller Screw
1454F	24808	Feed Dog Screw
1454E	24808	Throat Plate Guide Screw
1485J	24759	Oil Sight Gauge Window Retainer Screw (2)
1550J	24808	Guide (swing-out) Arm Lock Spring Screw Nut for 164311
1607J	24761	Thread (looper) Thread Eyelet (stationary) Nut for 164174
1628C	24797	Feed Bar Slide Block (back) Nut
1637K	24756	Presser Bar Lifting Lever Stop Screw Nut for 164080
1671C	24797	Feed Bar Connection Hinge Screw Stud Nut for 164276
1698J	24759	Machine Frame Oil Lead Screw Nut
1700J	24767	Cloth Plate Extension Screw Nut for 164108
1700J	24767	Cloth Plate Lock Spring Nut for 164108
1700J	24807	Presser Bar (swing-out) Lifting Screw Stud Nut
1700J	24809	Spreader Locking Screw Stud Nut for 164464
2102	24772	Tension (heavy) Disc for 164162 (4)
2102	24772	Tension (light) Disc for 164160 (2)
4879	24763	Foot Lifter Chain Connecting Link for 4885
4881	24763	Foot Lifter Treadle for 4885
4882	24763	Foot Lifter Treadle Shaft for 4885
4883		Foot Lifter Treadle Spring for 4885
4884	24763	Foot Lifter Treadle Stand for 4885
4885	24763	Foot Lifter Treadle complete, Nos. 4879, 4881, 4882, 4883, 4884 and two wood screws 1 in. No. 16 F.H.
6439	24763	Foot Lifter Chain, 36 in. to 45 in. with 56864 and 56865
		NOTE: When ordering No. 6439, give length required.
10875		Wrench (flat) for 1701 and 51649 (Accessories)
17022	24797	Feed Bar Slide Block (back) Nut Washer
17022	24809	Thread (looper) Stripper and Take-up Screw Washer
26026	24801	Screw Driver (Accessories)
42436	24808	Guide (swing-out) Hinge Screw Friction Washer for 164311
45057	24809	Looper Driving Shaft Crank Key Screw Washer
45057	24809	Spreader Driving Shaft Crank Key Screw Washer
50060K	24810	Presser Bar (swing-out) Opening Lever Hinge Screw for 164247
50073J	24810	Presser Bar (upright) Housing Screw (2)
50133C	24772	Tension (heavy) Screw Stud for 164156 (2)
50133C	24772	Tension (light) Screw Stud for 164156
50225J	24808	Presser Foot Clamping Plate Screw for 164474 and 164475
50267R	24808	Guide (swing-out) Arm Holder Screw for 164493 (2)

No.	Plate	Name
50311C	24764	Thread Unwinder Thread Guide (lower) Holder Set Screw for 151027
50318W	24761	Thread (looper) Plate Thread Bushing Screw for 164174
50370E	24809	Spreader Carrier Hinge Pin Set Screw for 164056
50379F	24809	Looper Set Screw for 164046
50421AL	24759	Machine Frame Oil Tube Set Screw
50421AL	24807	Presser Bar Bracket Stud Set Screw (back)
50421AL	24807	Thread (needle) Controller Lever Driving Lever Bearing Set Screw (long)
50421AL	24807	Thread (needle) Controller Lever Driving Lever Guide Holder Thread Tube Set Screw
50571J	24756	Machine Frame Cover (back) Screw (long) (2)
50608R	24763	Machine Base Plug Screw for 164184
51023W	24810	Machine Frame Oil Splash Guard (top) Screw (2)
51139J	24759	Oil Cooler Screw (long) (2)
51229J	24808	Presser Foot Guide Screw for 164474 and 164475
51326J	24763	Belt Guard Screw for 164201 (2)
51332C	24755	Machine Frame Rotary Shaft Bushing (intermediate) Set Screw
51362AL	24807	Presser Bar (swing-out) Pivot Screw Lock Washer Screw
51369C	24755	Machine Frame Rotary Shaft Ball Bearing Housing Screw (3)
51369J	24772	Machine Frame Top Cover Screw (3)
51630	24759	Oil Cooler Oil Tube Lock Nut
51649C	24755	Machine Frame Rotary Shaft Nut
51720C	24810	Needle Clamping Nut for 164275
51846	24810	Presser Bar Lifting Bracket Roller and Stud for 164137
56864	24763	Foot Lifter Chain Hook (large) for 6439
56865	24763	Foot Lifter Chain Hook (small) for 6439
59456	24809	Looper Carrier Screw Washer for 164212
59537	24772	Tension (heavy) Spring Bushing for 164162 (2)
59537	24772	Tension (light) Spring Bushing for 164160
131056	24755	Machine Frame Rotary Shaft Nut Washer
132565	24809	Spreader Carrier Hinge Pin for 164464
132583	24807	Thread (needle) Controller Lever Driving Lever Hinge Pin with 132584, for 164211
132584	24807	Thread (needle) Controller Lever Driving Lever Hinge Pin Oil Wick for 132583
138269	24759	Oil Cooler Oil Tube Sleeve for 164126
139017	24763	Machine Base Plug Screw Washer for 164184
139026	24755	Machine Frame Rotary Shaft Ball Bearing
140088R	24759	Machine Frame Oil Lead Screw
140159AL	24755	Looper Driving Shaft Crank Connection Cap (upper) Screw for 164052 (2)
140159AL	24755	Spreader Driving Shaft Crank Connection Cap (upper) Screw for 164052 (2)
140180J	24808	Presser Foot Thread Chain Guard Screw for 164493
140200J	24756	Machine Frame Cover (back) Slide Position Screw for 164080
140228C	24756	Presser Bar Lifting Lever Stop Screw for 164080
140239AL	24807	Thread (needle) Controller Lever Driving Lever Guide Holder Set Screw for 164181 (2)
140239AL	24807	Thread (needle) Controller Lever Driving Lever Guide Holder Set Screw
140393AL	24809	Looper Carrier Holder Set Screw (right) for 164047
140394E	24809	Looper Driving Shaft Bushing (back) Cap Screw
140394E	24809	Spreader Driving Shaft Bushing (back) Cap Screw
140395C	24759	Machine Frame Bracket Screw (small) for 164526 (3)
140396E	24759	Machine Frame Bracket Screw (large) for 164526
140416X	24755	Machine Pulley Cap Screw
140418E	24755	Machine Screw Stud (back)

From the library of: Disston and Needle Corp.

No.	Plate	Name
140509J	24767	Chip Guard Screw (upper)
140510C	24807	Presser Bar (swing-out) Pivot Screw
140596AL		Looper Carrier Holder Set Screw (left) for 164047
140596AL	24810	Needle Driving Shaft Crank Set Screw for 164114 (2)
140596AL	24809	Spreader Driving Lever Set Screw for 164062 (2)
150203	24764	Thread Unwinder Spool Rest Cushion (felt) for 151031 and 151163
151023	24764	Thread Unwinder Spool Rest with 858AL and three each 201528X, 228692 and 395243, for 151031 and 151163.
151024	24764	Thread Unwinder Spool Rest Rod for 151031 and 151163
151025	24764	Thread Unwinder Spool Rest Stand with two 1122C and three wood screws 1 in. No. 12 F.H., for 151031 and 151163
151026	24764	Thread Unwinder Thread Guide (lower) for 151031 and 151163
151027	24764	Thread Unwinder Thread Guide (lower) Support with 50311C, for 151031
151028	24764	Thread Unwinder Thread Guide (upper, hollow) for 151031 and 151163 (2)
151029	24764	Thread Unwinder Thread Guide (upper) Holder with four 453AL, for 151031 and 151163
151030	24764	Thread Unwinder Thread Guide Rod for 151031 and 151163
151031	24764	Thread Unwinder complete, for three spools, Nos. 151023, 151024, 151025, 151026, 151027, 151029, 151030, two 151028 and three 150203
151162	24806	Thread Unwinder Thread Guide (upper, solid) for 151163
151163	24806	Thread Unwinder complete, for four spools, Nos. 151023, 151024, 151025, 151026, 151027, 151029, 151030, 151162, 225259, two 151028 and four 150203
160725	24801	Oil Container for 160727
160726	24801	Oil Container Cap for 160727
160727	24801	Oil Container (filled, 5 oz. mfg. oil, light grade, not stain-less) Nos. 160725 and 160726 (Accessories)
160728	24801	Oil Container Spout, for use when filling Oil Reservoir (Accessories)
164001	24767	Chip Guard
164002	24767	Cloth Plate Extension for 164108
164003	24797	Feed Bar Hinge Pin (eccentric)
164004	24797	Feed Bar Slide Block (back) for 164276
164005	24797	Feed Bar Slide Block (front) for 164276
164006	24797	Feed Bar with 164010, for 164276
164008	24797	Feed Bar Connection Bearing for 164276
164009	24797	Feed Bar Connection Hinge Screw Stud for 164276
164010	24797	Feed Bar Connection Hinge Screw Stud Nut Position Pin for 164006
164017	24797	Feed Bar Connection for 164276
164020	24797	Feed Eccentric
		NOTE: Feed Eccentric No. 164020 is furnished in 4 to 16 and 18 stitches to the inch, unless otherwise stated No. 164020 (5 stitches to the inch) is supplied regularly.
164025	24755	Feed Lifting Eccentric
164031	24807	Thread (needle) Controller Lever Driving Lever with 620AL, for 164211
164032	24807	Thread (needle) Controller Lever Driving Lever Bearing
164034	24807	Presser Bar Bracket Stud for 164035
164035		Presser Bar Bracket Stud 164034 with 164036 and 164269
164036	24807	Presser Bar Bracket Stud Oil Wick (long) for 164035

No.	Plate	Name
164045	24809	Looper
164046	24809	Looper Carrier with 460AL, 50379F and 164202, for 164212
164047	24809	Looper Carrier Holder with 140393AL and 140596AL, for 164212
164048	24809	Looper Driving Shaft
164049	24809	Looper Driving Shaft Bushing (back)
164049	24809	Spreader Driving Shaft Bushing (back)
164050	24809	Looper Driving Shaft Bushing (front)
164051	24809	Looper Driving Shaft Crank with 1083C, for 164215
164052	24755	Looper Driving Shaft Crank Connection with two each 171AL and 140159AL, for 164215
164052	24755	Spreader Driving Shaft Crank Connection with two each 171AL and 140159AL, for 164216
164053	24809	Looper Driving Shaft Crank Thrust Bearing
164053	24809	Spreader Driving Shaft Crank Thrust Bearing
164054	24808	Looper Thread Tube
164056	24809	Spreader Carrier with 50370E, for 164464
164057	24809	Spreader Carrier Connection for 164464
164058	24809	Spreader Carrier Connection Guide Bar with 624AL and 168215, for 164464
164060	24809	Spreader Carrier Connection Guide Bar Bracket Oil Pad for 164463
164061	24809	Spreader Carrier Connection Hinge Stud with 1019AL, for 164464
164062	24809	Spreader Driving Lever with 1083C and two 140596AL, for 164464
164063	24809	Spreader Driving Shaft
164065	24809	Spreader Driving Shaft Bushing (front)
164066	24809	Spreader Driving Shaft Crank with 1083C, for 164216
164067	24809	Looper Driving Shaft Crank Key
164067	24809	Spreader Driving Shaft Crank Key
164068	24809	Spreader Locking Screw Stud for 164464
164071	24755	Machine Pulley Cap
164072		Machine Frame for 164526
164074	24756	Machine Frame Bottom Cover
164075	24756	Machine Frame Bottom Cover Gasket
164077	24759	Machine Frame Bracket Screw (large) Washer (fiber) for 164526
164078	24756	Machine Frame Cover (back) for 164080
164079	24756	Machine Frame Cover (back) Slide for 164080
164080	24756	Machine Frame Cover (back) complete, Nos. 238J, 1637K, 140200J, 140228C, 164078 and 164079
164081	24759	Machine Frame Oil Lead
164082	24759	Machine Frame Oil Plug Bracket
164083	24759	Machine Frame Oil Screen
164084	24759	Machine Frame Oil Splash Guard (internal)
164086	24759	Machine Frame Oil Tube with 164087
164087	24759	Machine Frame Oil Tube Wick for 164086
164088	24755	Machine Frame Plug
164089	24755	Machine Frame Rotary Shaft for 164090
164090		Machine Frame Rotary Shaft 164089 with 164097, 164215, 164216, 164217 and two each 164093 and 164232
164091	24809	Thread (looper) Stripper and Take-up for 164493
164092	24755	Machine Frame Rotary Shaft Ball Bearing Housing
164093	24755	Machine Frame Rotary Shaft Ball Sleeve (two pieces) for 164090 (2)
164094	24755	Machine Frame Rotary Shaft Bushing (front)
164095	24755	Machine Frame Rotary Shaft Bushing (intermediate)
164096	24755	Machine Frame Rotary Shaft Counterbalance with 1036AL
164097	24755	Machine Frame Rotary Shaft Key for 164090
164098	24755	Machine Frame Rotary Shaft Oil Sling and Ball Bearing Grease Retainer

No.	Plate	Name
164099	24755	Machine Frame Rotary Shaft Screw Stud
164100	24755	Machine Frame Rotary Shaft Thrust Bearing
164101	24772	Machine Frame Top Cover for 164214
164102	24772	Machine Frame Top Cover Gasket
164103	24772	Machine Frame Top Cover Oil Lead for 164214
164104	24767	Cloth Plate Plunger
164105	24767	Cloth Plate Plunger Spring
164106	24767	Cloth Plate Position Collar with two 624AL
164107	24767	Cloth Plate for 164108
164108	24767	Cloth Plate with Extension complete, Nos. 164002, 164107, 164205 and two each 914J and 1700J
164109	24810	Needle Clamp for 164275
164110	24810	Needle Driving Shaft with 164118, for 164275
164111	24810	Needle Driving Shaft Bushing
164112	24810	Needle Driving Shaft Bushing Cap
164113	24810	Needle Driving Shaft Bushing Oil Lead
164114	24810	Needle Driving Shaft Crank with 1083C and two 140596AL
164115	24810	Needle Driving Shaft Crank Ball for 164217
164116	24755	Needle Driving Shaft Crank Connection with two each 171AL and 896AL, for 164217
164117	24810	Needle Holder for 164275
164118	24810	Needle Stop Pin for 164110
164119	24755	Oil Agitator
164120	24759	Oil Cooler with two 164125
164121	24759	Oil Cooler Cover for 164123
164122	24759	Oil Cooler Cover Gasket
164123	24759	Oil Cooler Cover 164121 with 164135
164124	24759	Oil Cooler Gasket
164125	24759	Oil Cooler Oil Pipe (outlet) for 164120 (2)
164126	24759	Oil Cooler Oil Tube with 138269 and 164128
164127	24759	Oil Cooler Oil Tube Coupling
164128	24759	Oil Cooler Oil Tube Wick for 164126
164131	24759	Oil Sight Gauge Background Disc
164132	24759	Oil Sight Gauge Background Disc Gasket
164132	24759	Oil Sight Gauge Window Gasket
164132	24759	Oil Sight Gauge Window Retainer Gasket
164133	24759	Oil Sight Gauge Window
164134	24759	Oil Sight Gauge Window Retainer
164135	24759	Oil Cup for filling Machine for 164123
164136	24807	Presser Bar Bracket for 164211
164137	24810	Presser Bar Lifting Bracket with 462AL, 624AL and 51846, for 164247
164138	24810	Presser Bar Lifting Lever for 164247
164139	24810	Presser Bar Lifting Lever Spring for 164247
164141	24807	Presser Bar (swing-out) Lifting Screw Stud
164142	24810	Presser Bar (swing-out) Opening Lever for 164247
164143	24810	Presser Bar (upright) for 164247
164144	24810	Presser Bar (upright) Spring for 164247
164146	24808	Presser Foot Chaining-off Finger for 164475
164147	24908	Presser Foot Clamping Plate for 164474 and 164475
164153	24807	Thread (needle) Controller Lever for 164211
164155	24772	Tension (heavy) Regulating Thumb Nut for 164156 (2)
164155	24772	Tension (light) Regulating Thumb Nut for 164156
164156		Tension (heavy) Screw Stud 50133C with 164155, for 164162 (2)
164156		Tension (light) Screw Stud 50133C with 164155, for 164160
164157	24772	Tension (light) Spring for 164160
164158	24772	Tension (heavy) Spring Cover for 164162 (2)
164158	24772	Tension (light) Spring Cover for 164160
164159	24772	Tension (needle thread) Thread Guide
164160	24772	Tension (light) complete, Nos. 59537, 164156, 164157, 164158 and two 2102

No.	Plate	Name
164161	24772	Tension (heavy) Spring for 164162 (2)
164162	24772	Tension (heavy) complete, Nos. 59537, 164156, 164158, 164161 and two 2102 (2)
164163	24761	Thread (looper) Stripper and Take-up Eyelet (adjustable) for 164174
164164	24761	Thread (looper) Thread Eyelet (movable) for 164174
164165	24761	Thread (looper) Thread Eyelet (stationary) for 164174
164166	24761	Thread (looper) Tube for 164174
164167	24761	Thread (looper) Plate with 624AL, for 164174
164168	24761	Thread (looper) Plate Cover for 164206
164169	24761	Thread (looper) Plate Cover Hinge for 164206
164170	24761	Thread (looper) Plate Cover Hinge Pin for 164206
164171	24761	Thread (looper) Plate Cover Spring for 164174 (2)
164173	24761	Thread (looper) Plate Thread Bushing for 164174
164174		Thread (looper) Plate complete, Nos. 1423J, 1443J, 1607J, 50318W, 164163, 164164, 164165, 164166, 164167, 164173, 164206 and two each 332J and 164171
164175	24809	Thread (looper) Take-up for 164493
164176	24809	Thread (looper) Take-up Plate
164177	24807	Thread Eyelet (needle thread) for 164210
164179	24808	Throat Plate Guide with 853AL, for 164493
164180	24807	Thread (needle) Controller Lever Driving Lever Guide for 164210
164181	24807	Thread (needle) Controller Lever Driving Lever Guide Holder with two 140239AL, for 164210
164182	24807	Thread (needle) Controller Lever Driving Lever Guide Holder Thread Tube for 164210
164183	24763	Belt Guard for 164201
164184	24763	Machine Base with 50608R, 139017 and two each wood screws 3/4 in. No. 8 R.H. and 1-1/4 in. No. 6 F.H.
164188	24763	Machine Cushion (large) (2)
164189	24763	Machine Cushion (small) (2)
164190	24763	Machine Pad (felt)
164194	24810	Pressure Regulating Thumb Screw for 164247
164196	24801	Threader (Accessories) (6)
164197	24801	Wrench (socket) Accessories
164198	24801	Presser Bar Lifting Chain Spring (under table) Accessories
164199	24763	Belt Guard Bracket (back) for 164201
164200	24763	Belt Guard Bracket (front) for 164201
164201	24763	Belt Guard (adjustable) complete, Nos. 164183, 164199, 164200 and two each 51326J and wood screws 3/4 in. No. 7 F.H.
164202	24809	Looper Stop Pin for 164046
164203	24801	Feed Eccentric Extractor (not regularly furnished with machine) Accessories
164204	24801	Tweezers (Accessories)
164205	24767	Cloth Plate Lock Spring for 164108
164206		Thread (looper) Plate Cover 164168 with 164169 and 164170, for 164174
164207	24759	Machine Frame Bracket Key for 164528
164210	24807	Thread (needle) Controller Lever Driving Lever Guide Holder 164181 with 197J, 164177, 164180 and 164182
164211		Thread (needle) Controller Lever Driving Lever 164031 with 132583, 164035, 164136 and 164153
164212		Looper Carrier Holder 164047 with 1324C, 59456 and 164046
164214		Machine Frame Top Cover 164101 with 330J, 164103 and two 164418
164215		Looper Driving Shaft Crank 164051 with 164052, for 164090
164216		Spreader Driving Shaft Crank 164066 with 164052, for 164090

From the library of: Diamond Needle Co.

No.	Plate	Name
164217		Needle Driving Shaft Crank Connection 164116 with 164115, for 164090
164219	24809	Spreader Position Collar with 904E
164229	24759	Machine Frame Bracket Screw (large) Washer (felt)
164231	24755	Machine Pulley (round belt and "V" belt) with two 448AL
164232	24755	Machine Frame Rotary Shaft Ball Sleeve Guide for 164090 (2)
164246	24810	Presser Bar (upright) Housing for 164247
164247		Presser Bar (upright) Housing complete, Nos. 50060K, 164137, 164138, 164139, 164142, 164143, 164144, 164194 and 164246
164252	24809	Spreader for 164493
164269		Presser Bar Bracket Stud Oil Wick (short) for 164035
164275		Needle Driving Shaft 164110 with 51720C, 164109 and 164117
164276		Feed Bar complete, Nos. 1671C, 164004, 164005, 164006, 164008, 164009 and 164017
164277	24797	Feed Bar Guide Roller
164278	24797	Feed Bar Spacing Collar
164285	24772	Tension (looper thread) Thread Guide (left)
164286	24772	Tension (looper thread) Thread Guide (right)
164293	24809	Looper Driving Shaft Bushing (back) Cap Screw Washer
164293	24809	Spreader Driving Shaft Bushing (back) Cap Screw Washer (fiber)
164294	24807	Cover, for covering Knife (movable) Mechanism Opening
164297	24808	Guide (swing-out) Arm for 164311
164298	24808	Guide (swing-out) Arm Holder for 164311
164299	24808	Guide (swing-out) Extension (upper) for 164503
164303	24808	Presser Foot Guide for 164474 and 164475
164311	24808	Guide (swing-out) with Arm and Holder complete for 164493, Nos. 1423J, 1425J, 1550J, 42436, 164297, 164298, 164503, 164541 and two 1443J
164345	24797	Feed Eccentric Cover Oil Wick for 164400
164350	24807	Presser Bar (swing-out) for 164493
164351	24807	Presser Bar (swing-out) Pivot Screw Lock Washer
164381	24811	Thread (needle) Controller for 164493
164397	24809	Spreader Carrier Connection Hinge Stud Adjusting Pin for 164464
164398	24797	Feed Eccentric Cover for 164403
164400	24797	Feed Eccentric Cover Bracket with 164345, for 164403
164401	24797	Feed Eccentric Cover Latch Spring for 164403
164403	24797	Feed Eccentric Cover complete, Nos. 629K, 164398, 164400, 164401 and two 227J
164416		Presser Bar (upright) Spring (heavy)
164418	24772	Tension Thread Eyelet for 164214 (2)
164438	24808	Presser Foot Chaining-off Finger for 164474
164440	24808	Throat Plate for 164493
164459	24801	Gauge (not regularly furnished with machine) Accessories
164461		Machine Frame Oil Tube Wick Retainer
164462	24807	Lint Stripper with 735AL
164463	24809	Spreader Carrier Connection Guide Bar Bracket with 164060 and two 462AL, for 164464
164464		Spreader Driving Lever 164062 with 1443J, 1700J, 132565, 164056, 164057, 164058, 164061, 164068, 164397 and 164463
164469	24808	Feed Dog for 164493
164471	24808	Presser Foot Body for 164474 and 164475
164474	24808	Presser Foot complete, for light and medium fabrics, for 164493, Nos. 50225J, 51229J, 164147, 164303, 164438 and 164471

No.	Plate	Name
164475	24808	Presser Foot complete, for heavy-weight fabrics, for 164493, Nos. 50225J, 51229J, 164146, 164147, 164303 and 164471
164476	24808	Presser Foot Thread Chain Guard for 164493
164492	24810	Machine Frame Oil Splash Guard (top) for 164493
164493	24811	Set of Fittings complete for Pants Serging for light and medium or heavy-weight fabrics, for two-thread stitch, 1/4 in. bight, Nos. 140180J, 164091, 164175, 164179, 164252, 164311, 164350, 164381, 164440, 164469, 164474, or 164475, 164476, 164492 and two 50267R
164502	24808	Guide (swing-out) Extension (lower) for 164503
164503		Guide (swing-out) with Extensions complete for 164311, Nos. 197J, 164299, 164502 and 164530
*164526		Machine Frame complete, Nos. 140396E, 164072, 164077, 164528 and three 140395C
*164527		Machine Frame Bracket for 164528
*164528		Machine Frame Bracket 164527 with 164207 and two 187E, for 164526
164530	24808	Guide (swing-out) for 164503
164541	24808	Guide (swing-out) Arm Lock Spring for 164311
168215		Spreader Carrier Connection Guide Bar Oil Wick for 164058
201018C	24806	Thread Unwinder Spool Rest Set Screw for 225259
201528X		Thread Unwinder Spool Pin Nut for 151023 and 225259
225259		Spool Rest with 201018C, 201528X, 228692 and 228693 (one spool) for 151163
228692		Thread Unwinder Spool Pin for 151023 and 225259
228693		Thread Unwinder Spool Pin Washer for 225259
395243		Thread Unwinder Spool Pin Washer for 151023 (3)

SINGER Needles should be used
in SINGER Machines.
These Needles and their Containers
are marked with the
Company's Trade Mark "SIMANCO.***" 1

Needles in Containers marked
"FOR SINGER MACHINES"
are NOT **SINGER** made needles. 2

SINGER Needles should be used
 in SINGER Machines.
 These Needles and their Containers
 are marked with the
 Company's Trade Mark "SIMANCO.™" 1

Needles in Containers marked
 "FOR SINGER MACHINES"
 are NOT **SINGER** made needles. 2

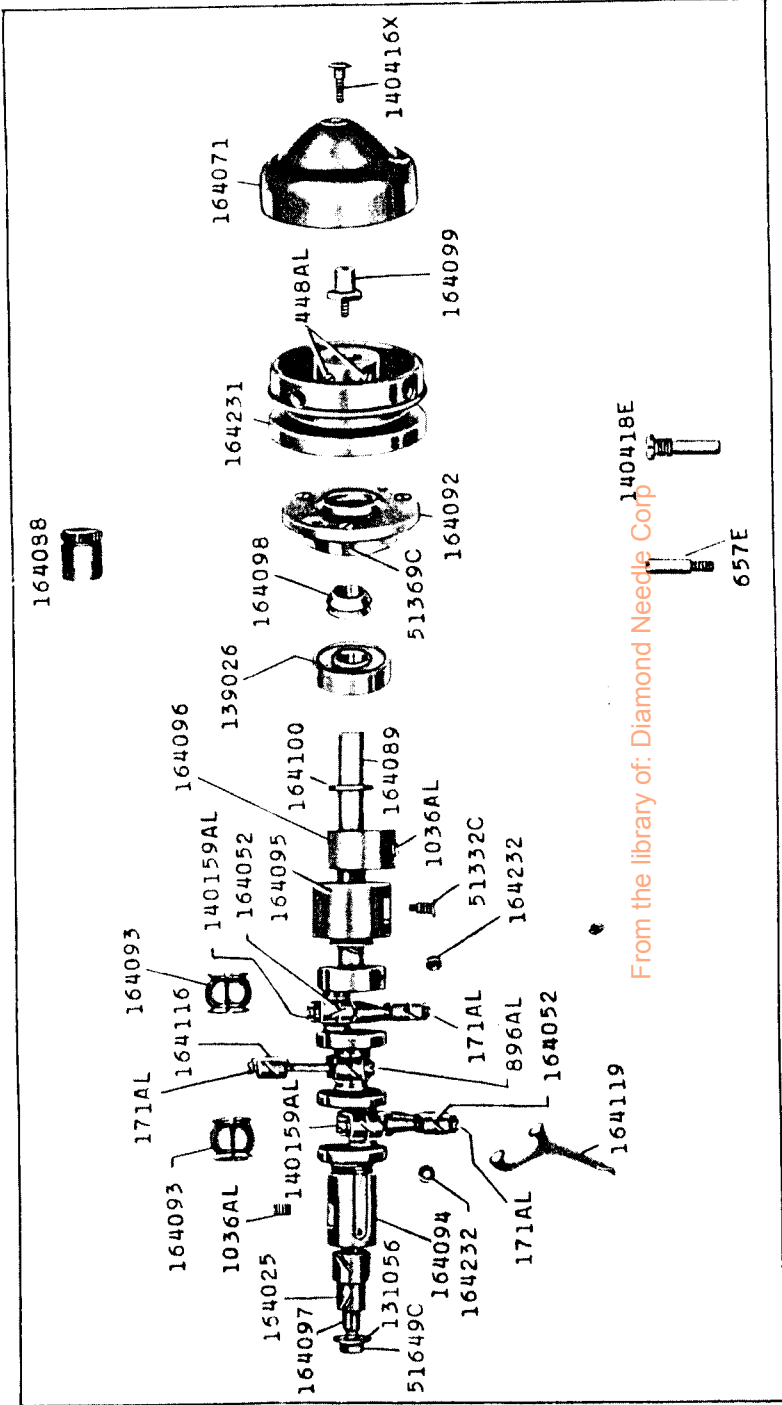

24756 - 1/3

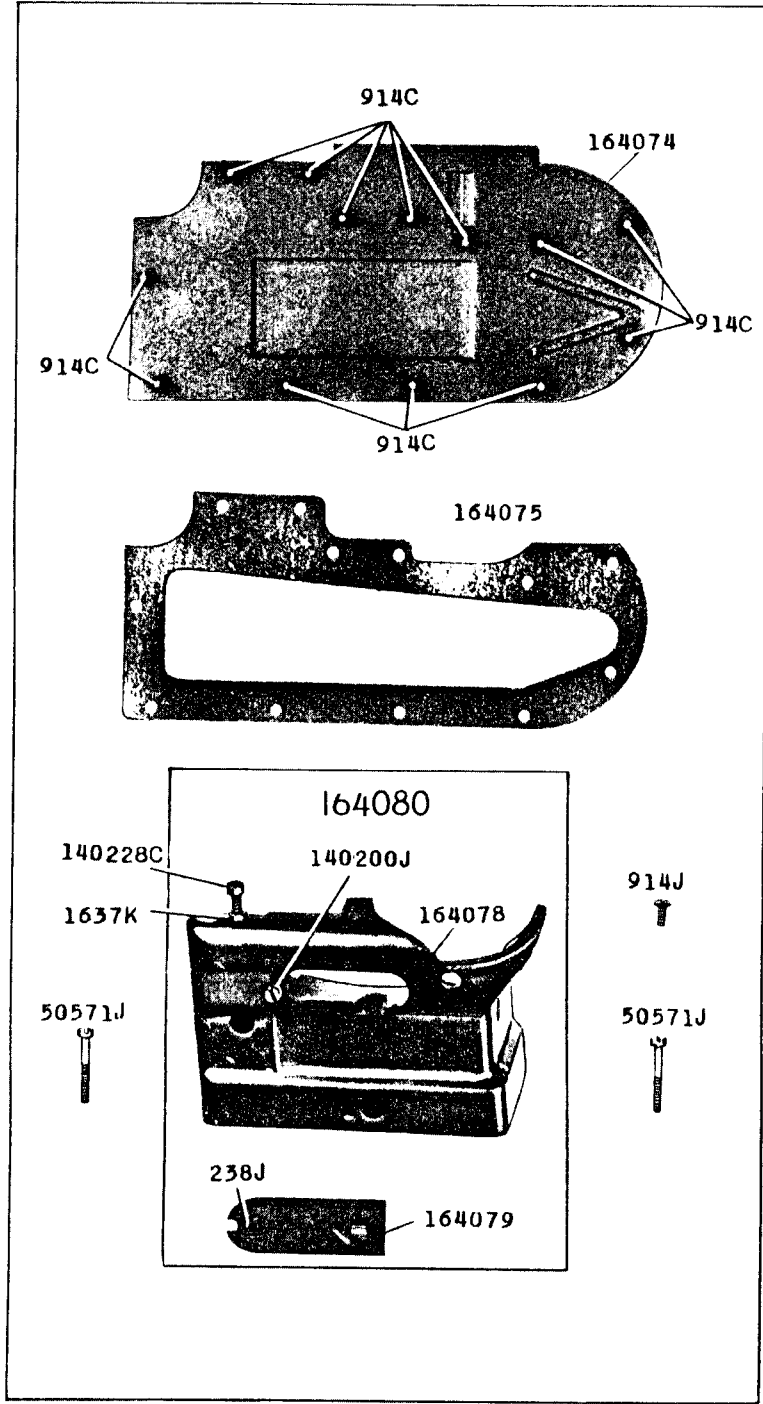

24759 - 1/3

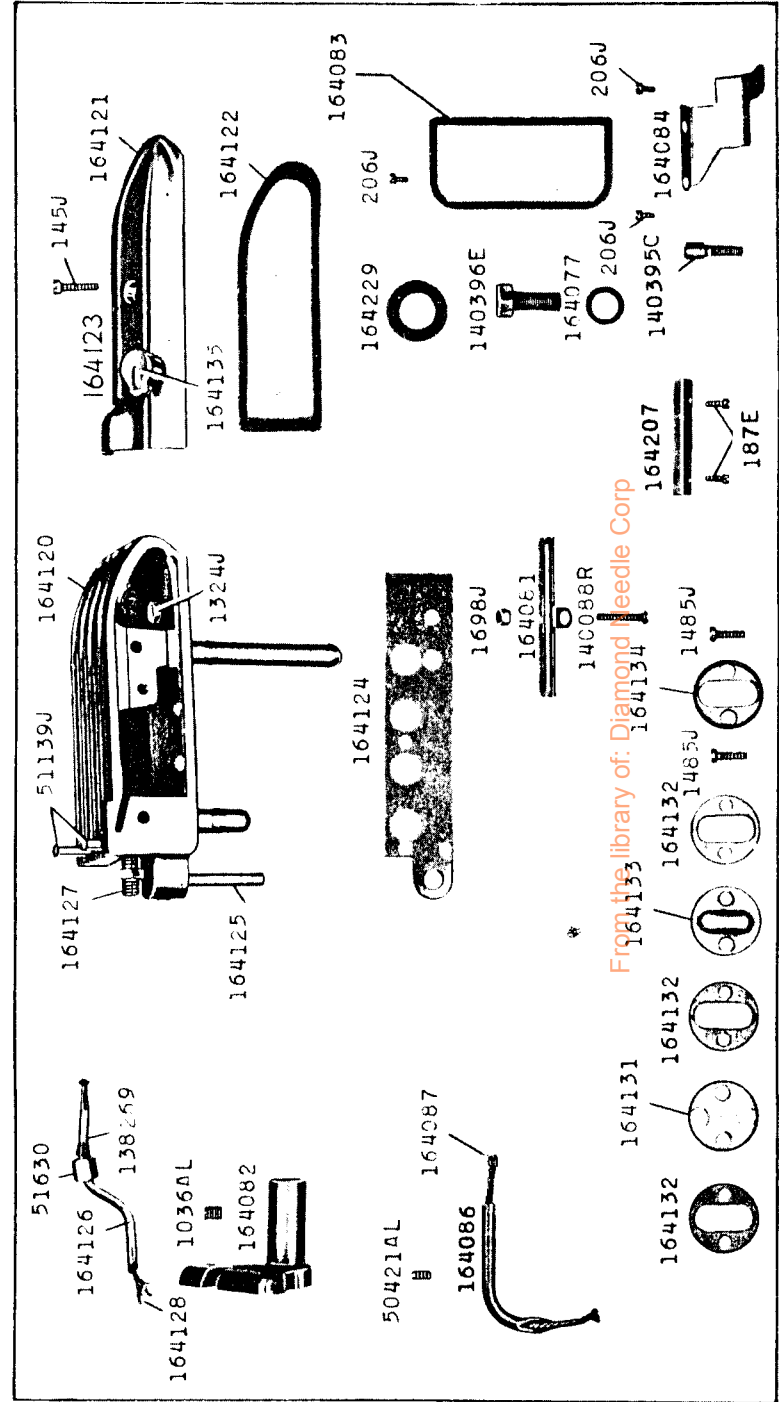

24761 - 2/3

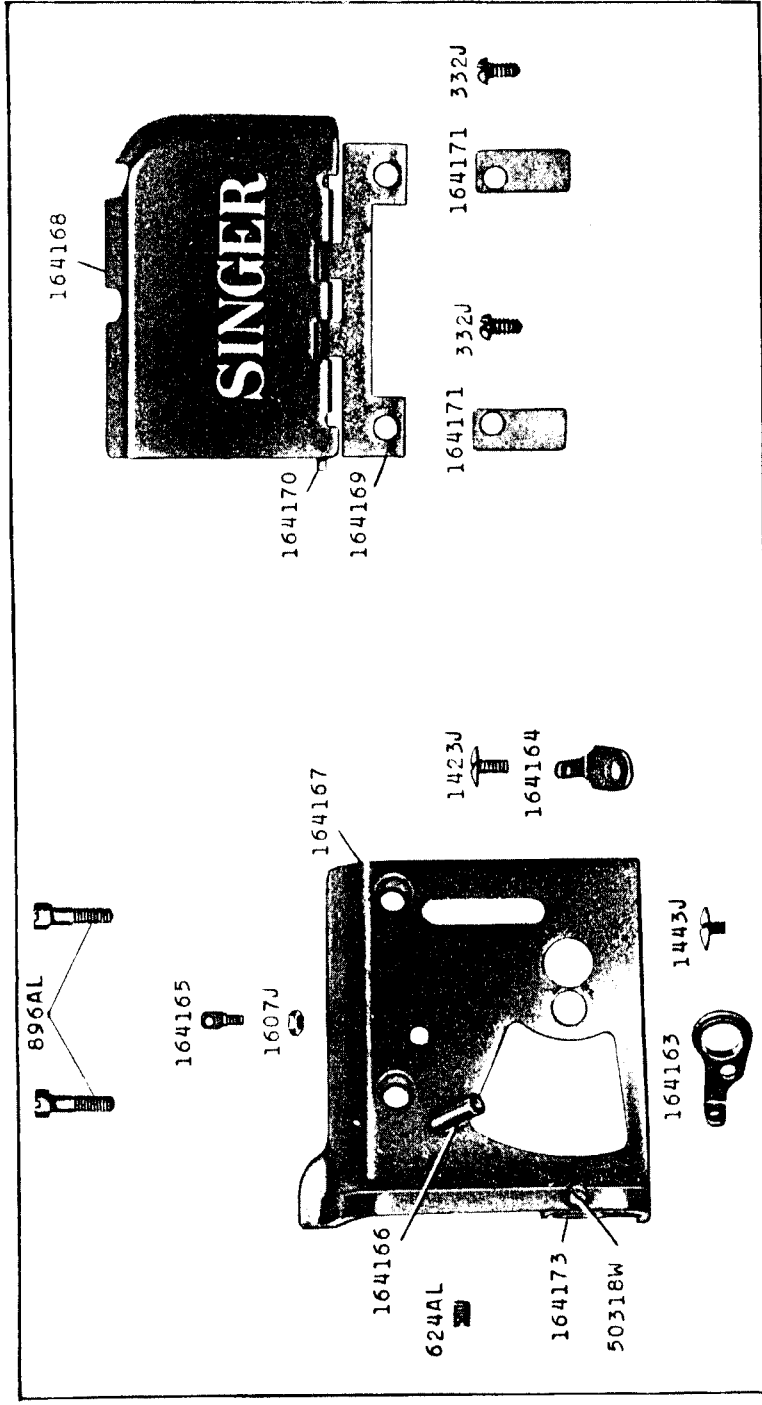

24763 - 1/4

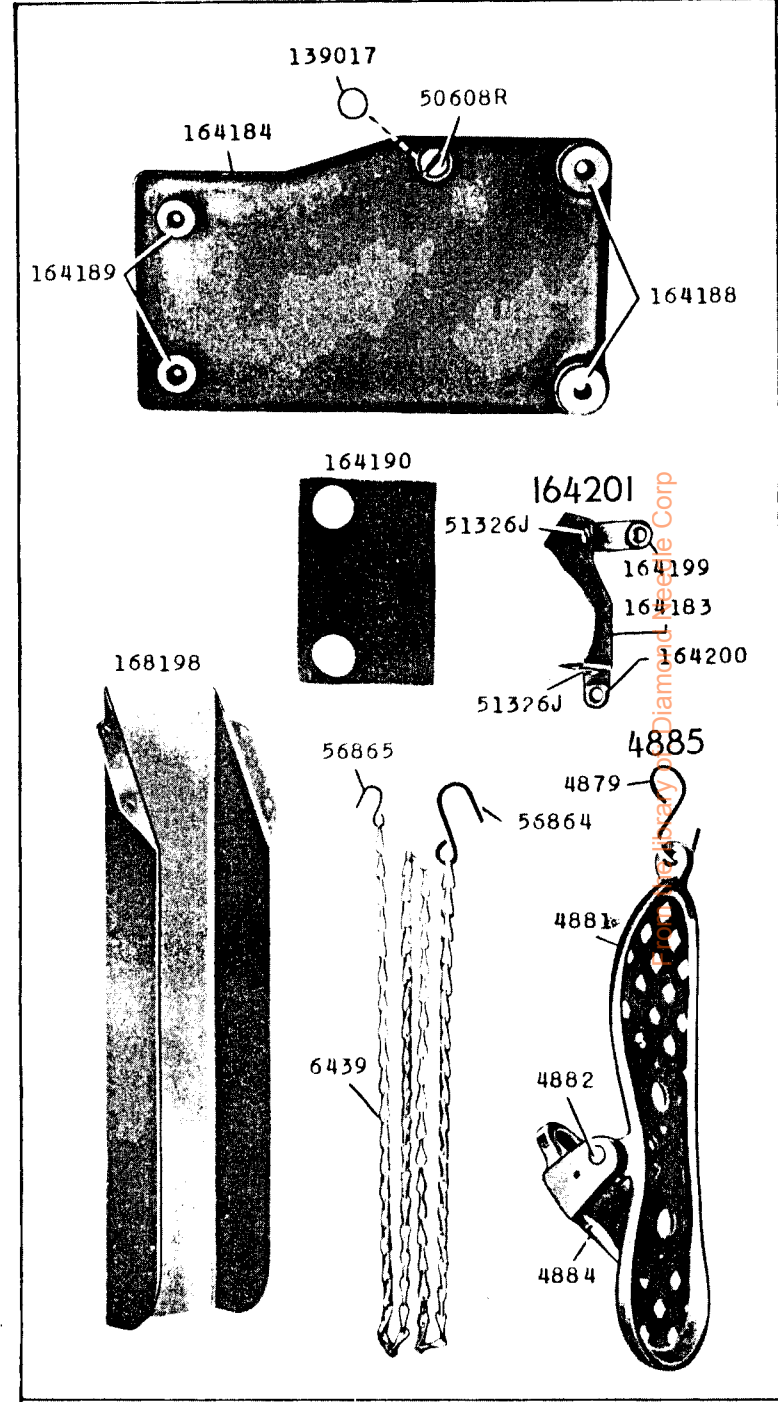

24764 - 1/6

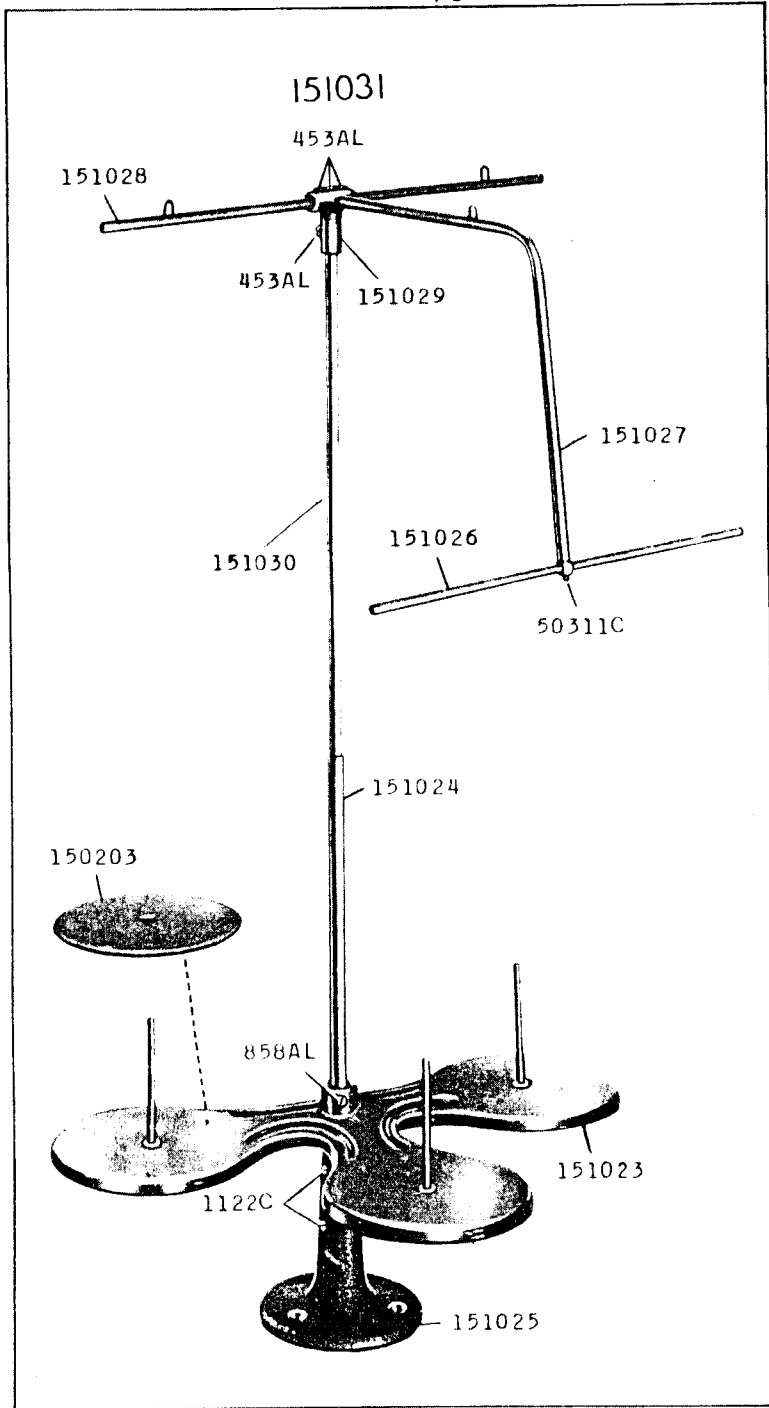

24767 - 1/2

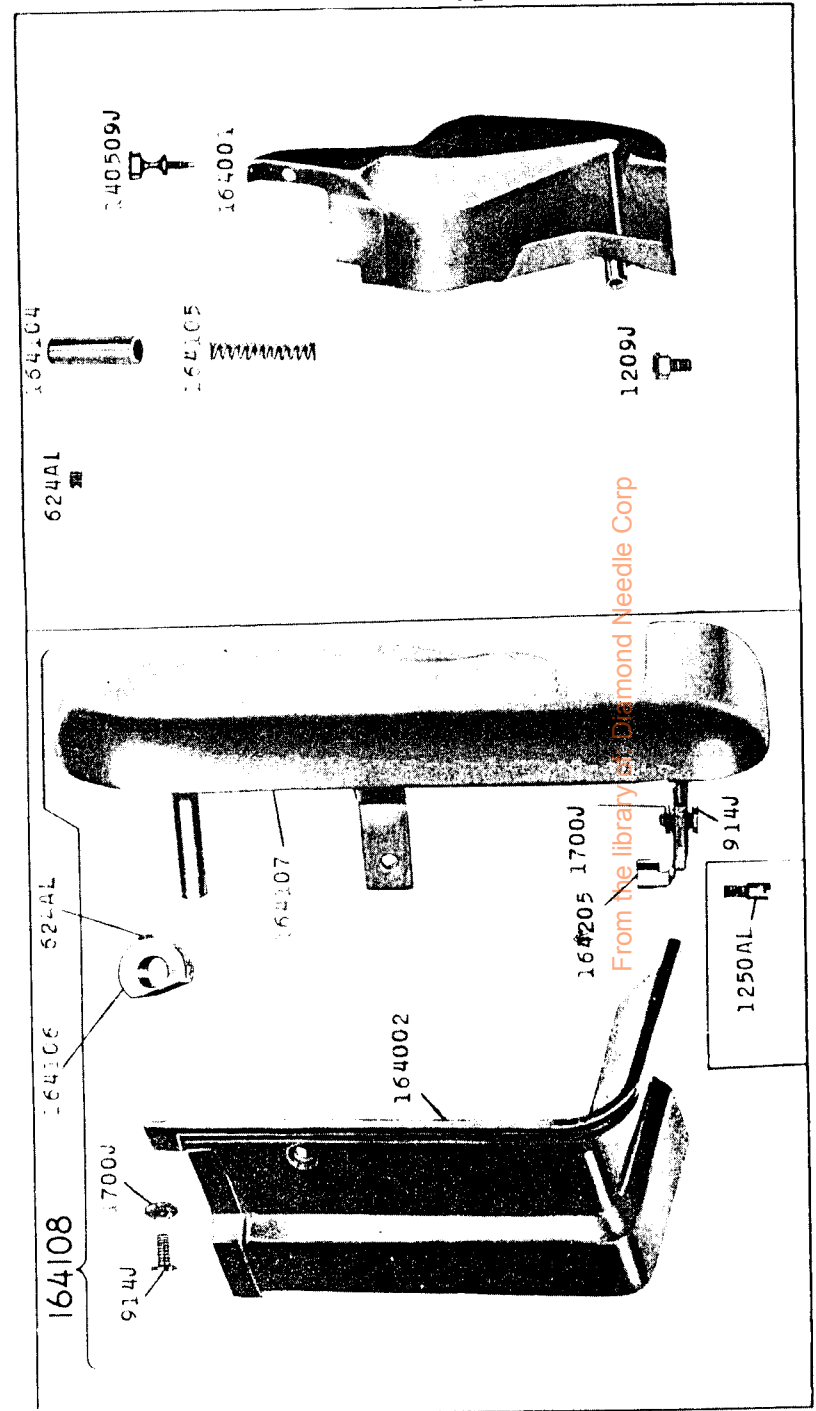

24801 - 1/2

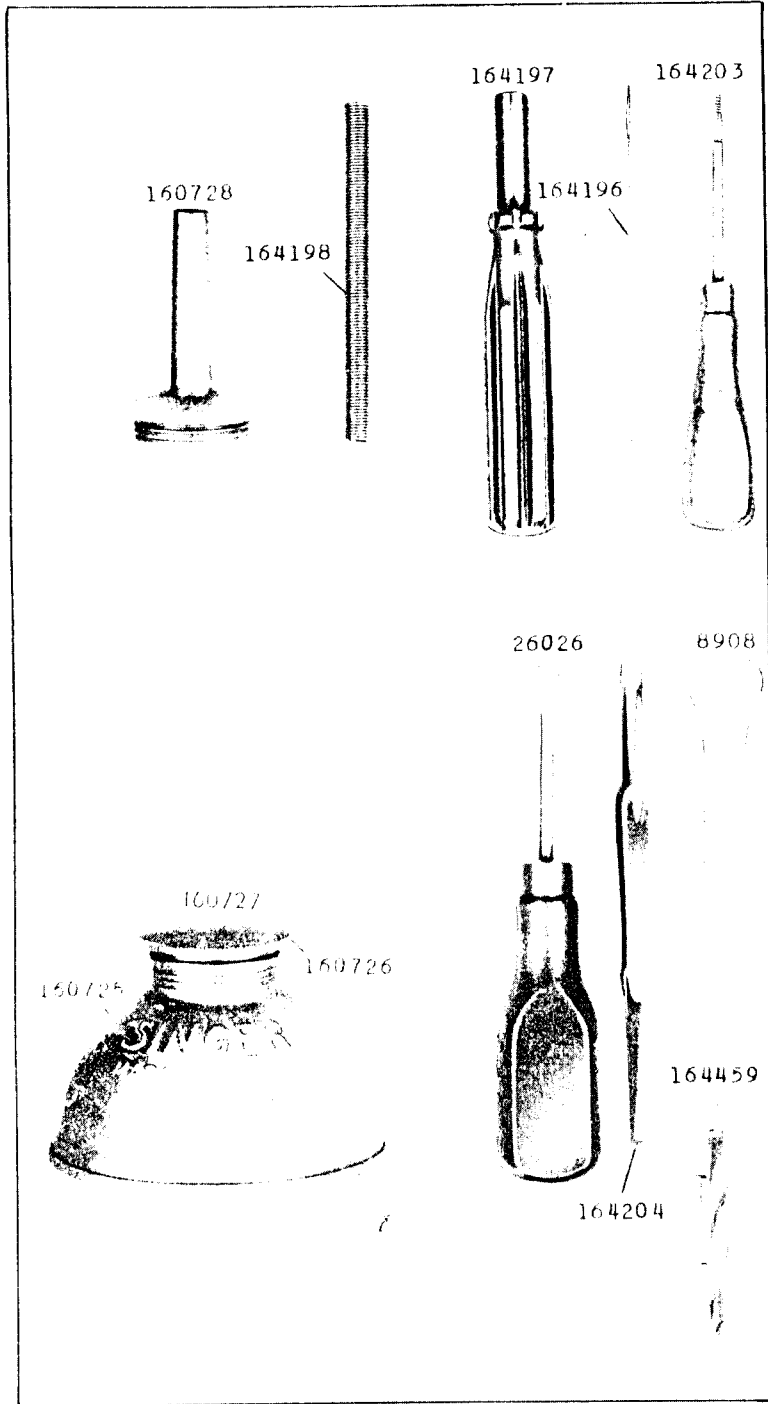

24806 - 1/6

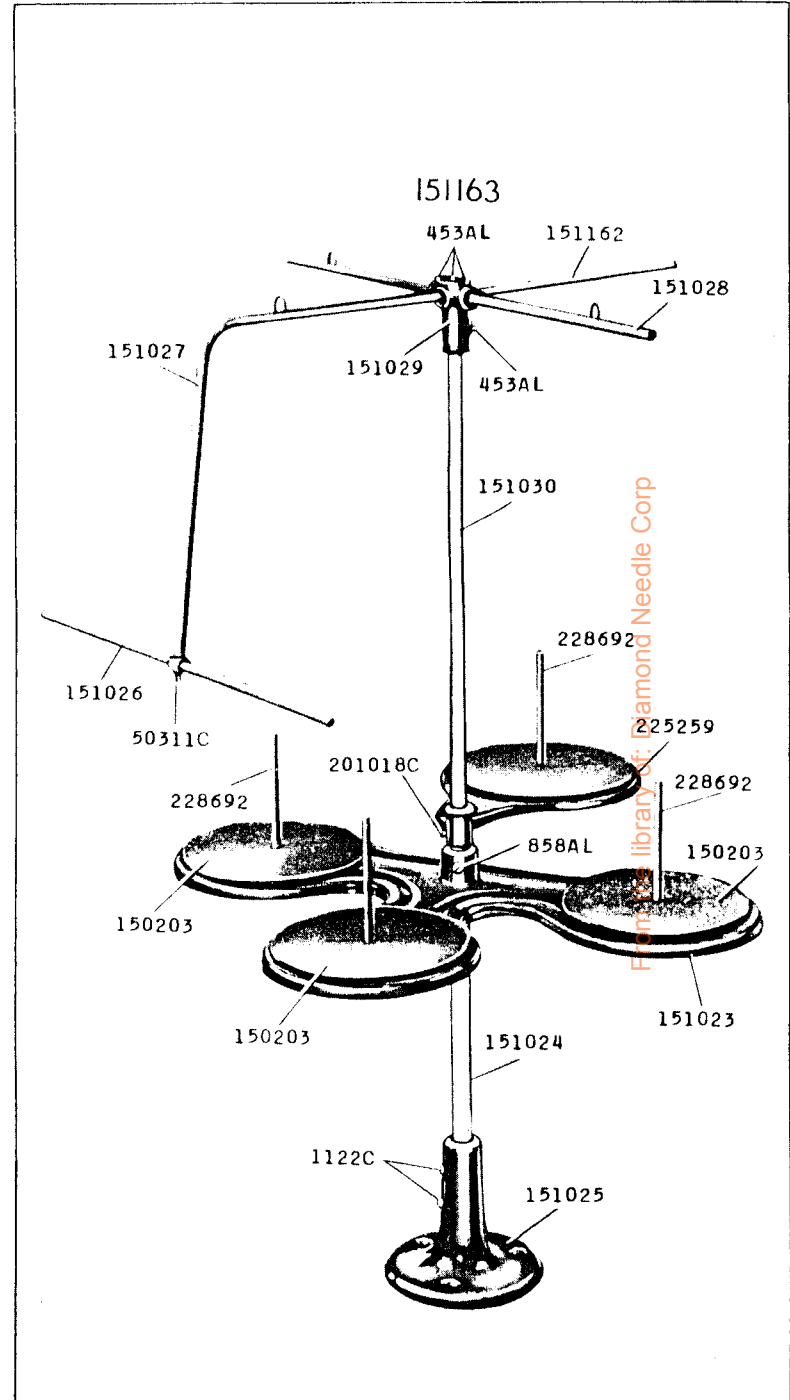

24807-1/2

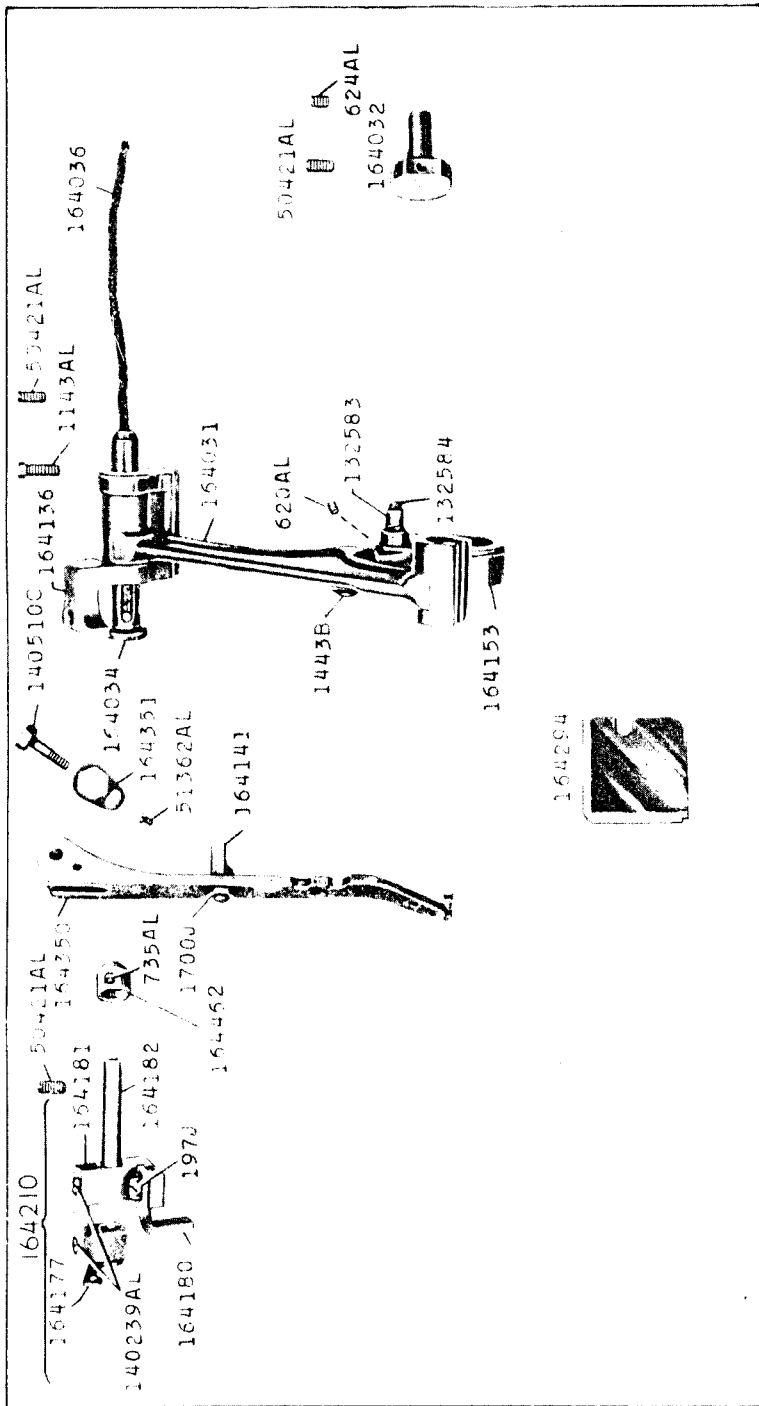

24808-2/3

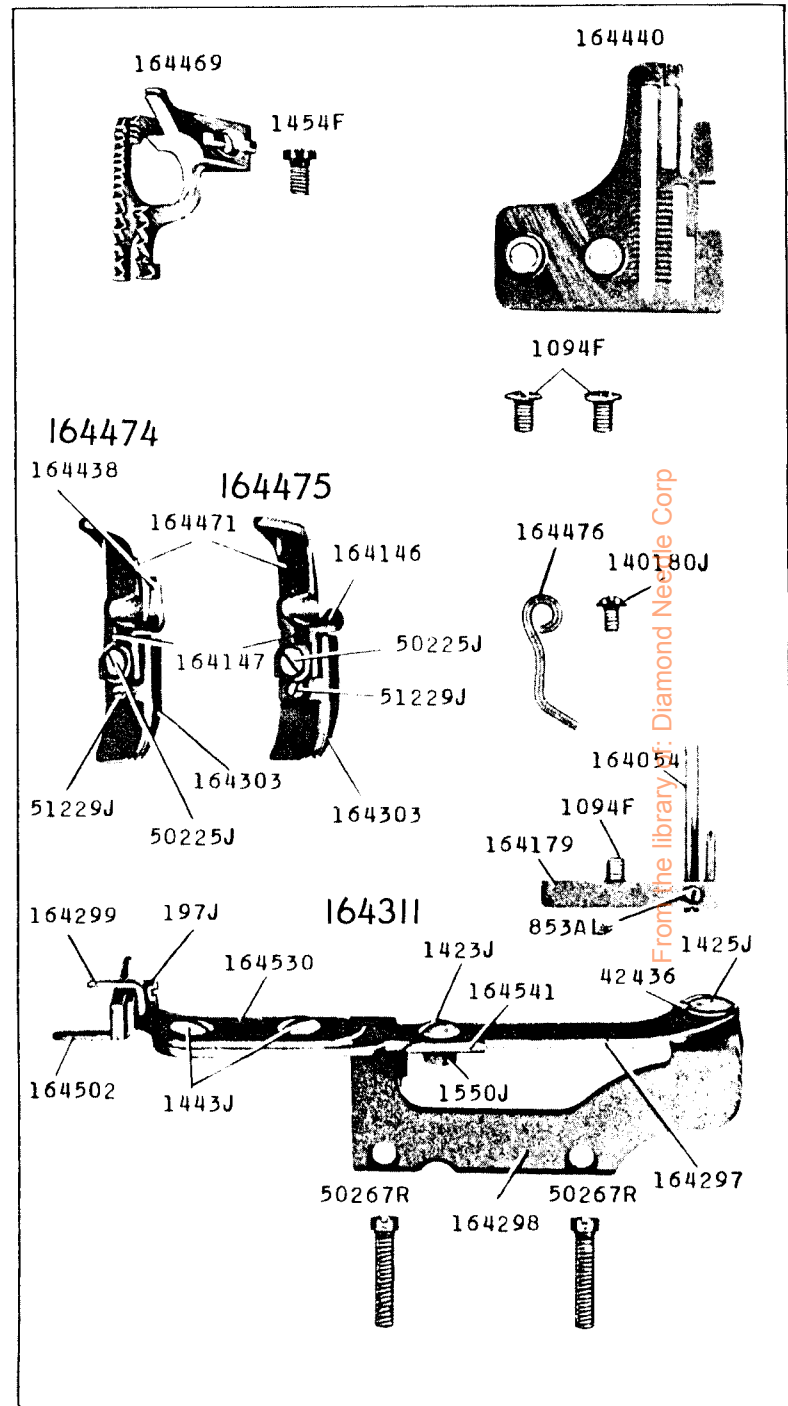

24809-1/2

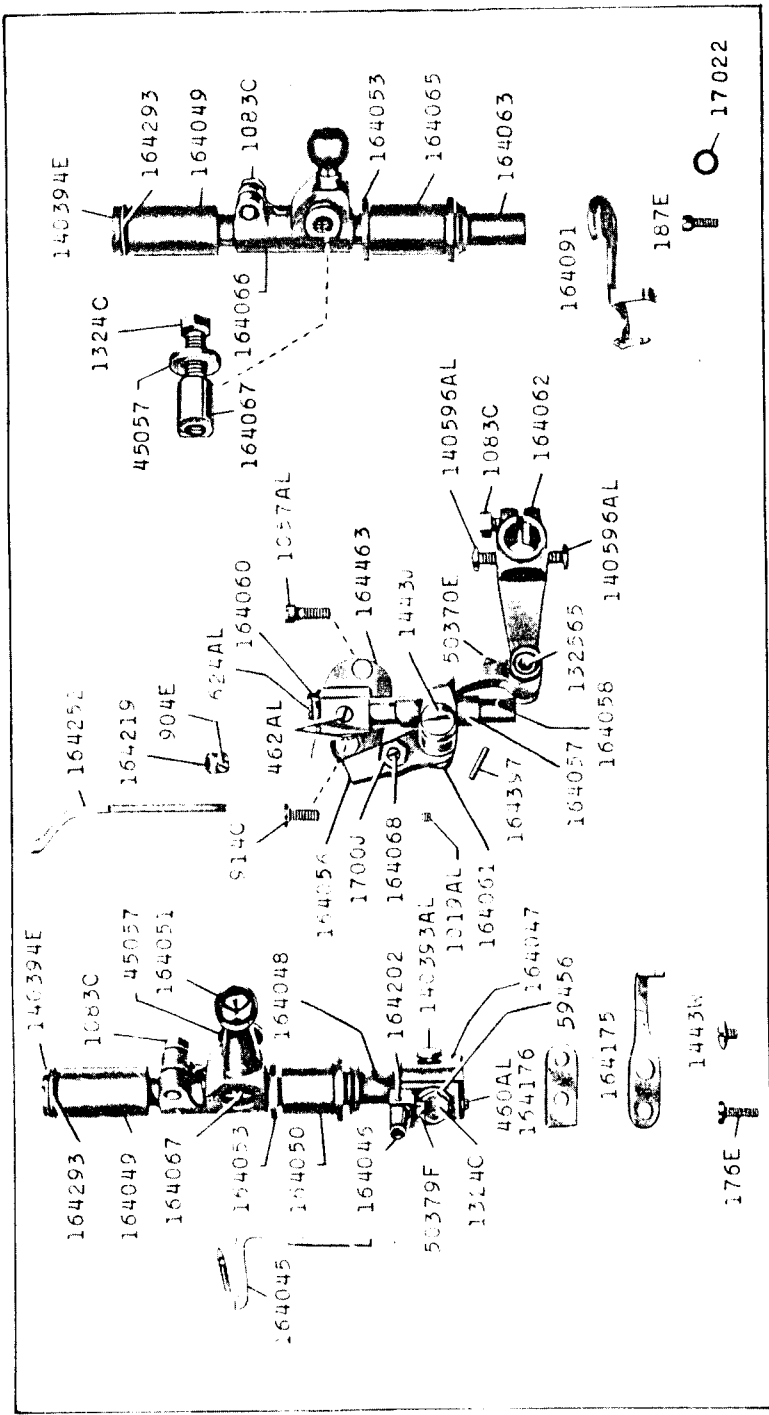

24810-1/2

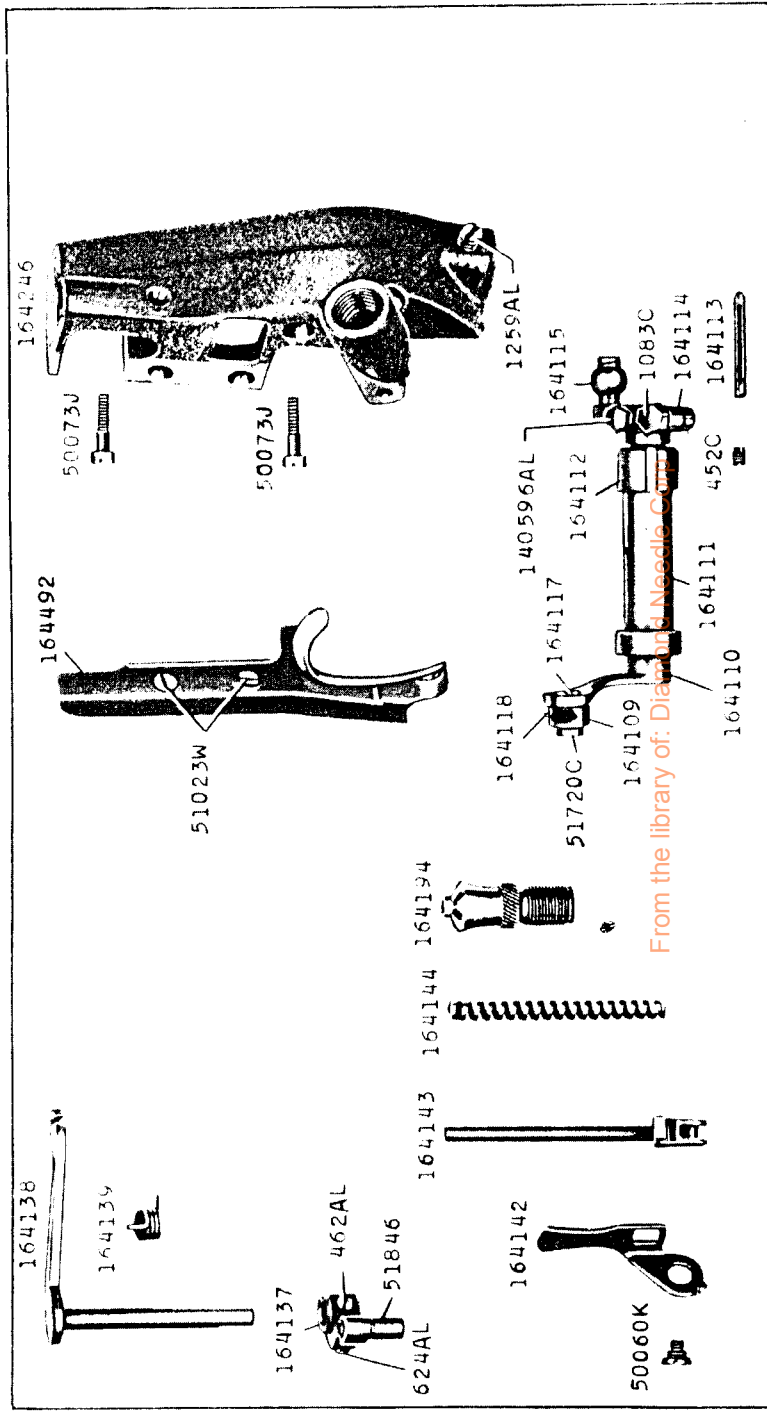

24811-1/2

